

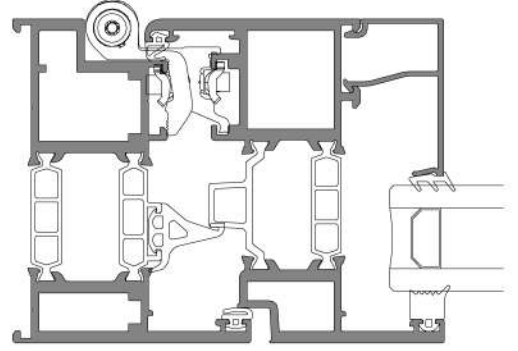

**WD86T**



## TEKNİK ÖZELLİKLER / TECHNICAL PROPORTEIS

<b>KASA DERİNLİĞİ / FRAME DEPTH</b>	<b>85,7 mm</b>
<b>KANAT DERİNLİĞİ / SASH DEPTH</b>	<b>85,7 mm</b>
<b>ET KALINLIĞI / WALL THICKNESS</b>	<b>2 mm - 3 mm</b>
<b>MAKS. CAM KALINLIĞI / MAX. GLASS THICKNESS</b>	<b>26 - 56 mm</b>
<b>ISI BARIYER / THERMAL BREAK</b>	<b>34 mm</b>
<b>AKS BİNİ / 9 Axis ( 18 )</b>	<b>9 Aks - 18 Bini</b>

## PERFORMANS DEĞERİ / PERFORMANCE VALUES

<b>EN 12152 Hava Geçirgenliği / Air Permability</b>	<b>Class 4 - 600 Pa</b>
<b>EN 12154 Su Sızdırmazlığı / Water Tightness</b>	<b>Class 9A - 600 Pa</b>
<b>TS EN 13830 Rüzgar Yüküne Dayanım / Wind Resistance</b>	<b>Class C4 - 1800 Pa</b>
<b>Min. Max. Termal Isı Yalıtımı / Thermal Insulation Value (UF)</b>	<b>Uf: 1,8 - 2,27 W/(m<sup>2</sup>.K)</b>

## UYGULAMA SEÇENEKLERİ / APPLICATION OPTIONS

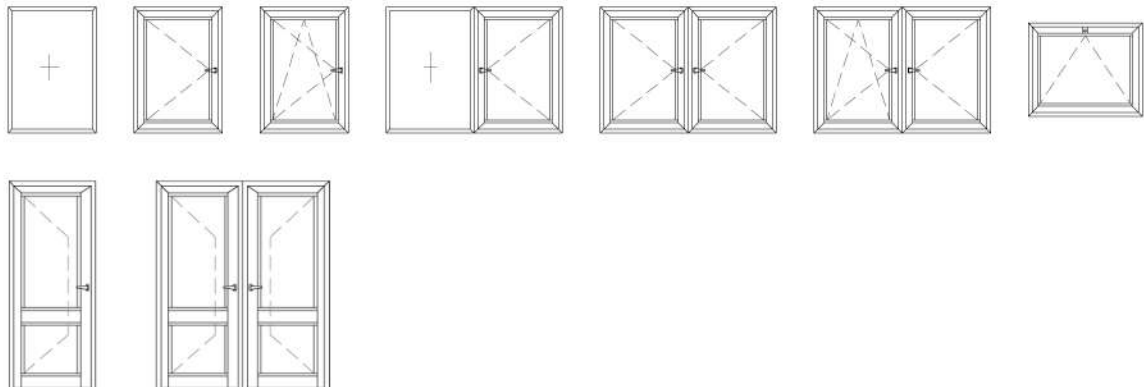

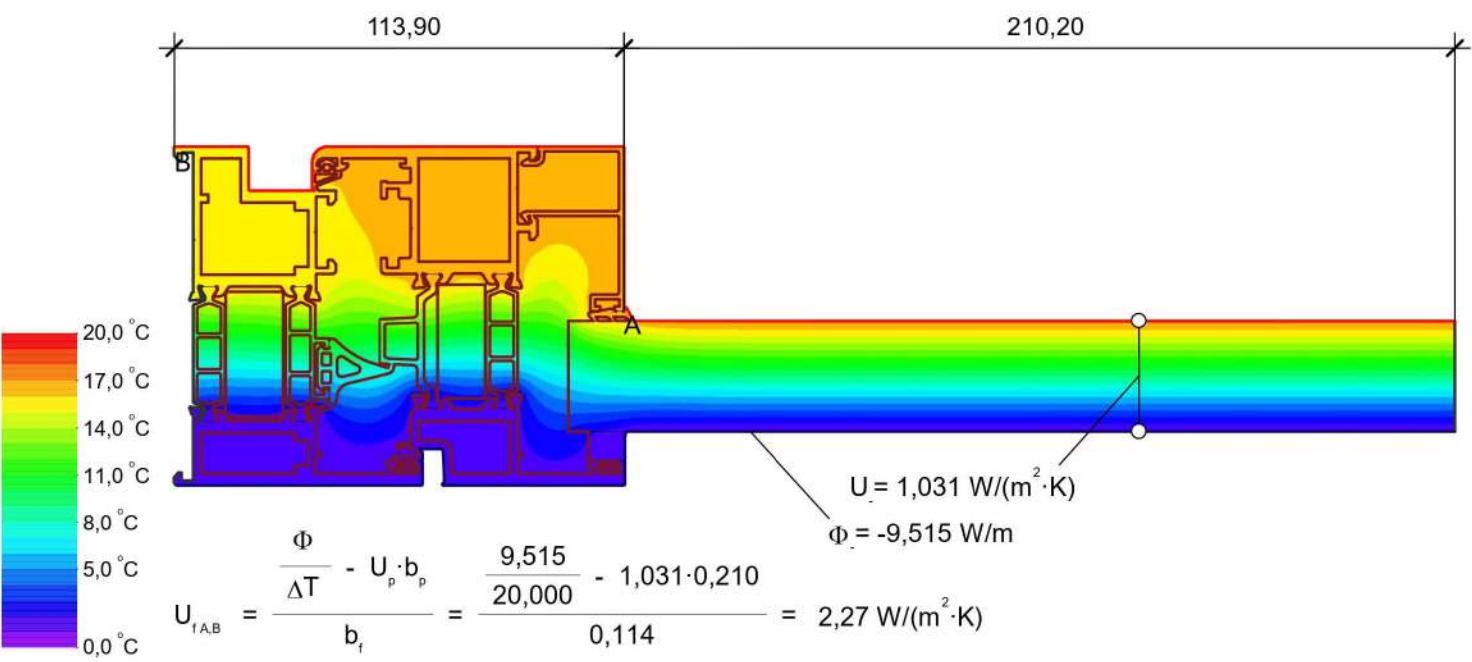









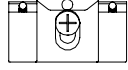
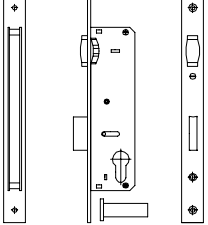
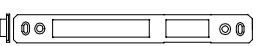

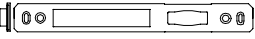
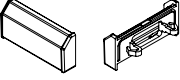

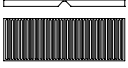
Material	$\lambda$ [W/(m·K)]	$\epsilon$	Boundary Condition	$q$ [W/m <sup>2</sup> ]	$\theta$ [°C]	$R$ [(m <sup>2</sup> ·K)/W]	$\epsilon$
Aluminium (Si Alloys)	160,000	0,900	Epsilon 0.9				0,900
EPDM (ethylene propylene diene monomer)	0,250	0,900	Exterior, frame	0,000		0,040	
Panel	0,035	0,900	Interior, normal, horizontal		20,000	0,130	
Polyamid 6.6 with 25% glass fibre	0,300	0,900	Symmetry/Model section	0,000			
Unventilated air cavity	anisotropic						

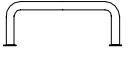
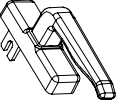
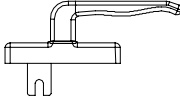
PROF L KES T PROFILE SECTION	PROF L KODU PROFILE CODE	PROF L ADI PROFILE NAME	Jx cm <sup>4</sup>	Jy cm <sup>4</sup>	A IRLIK (kg/m) WEIGHT
	34-10901-10902	KASA PROF L FRAME PROFILE	74,02 cm <sup>4</sup>	20,23 cm <sup>4</sup>	2,341 kg/mt
	34-10903-10904	KASA PROF L FRAME PROFILE	72,97 cm <sup>4</sup>	17,15 cm <sup>4</sup>	2,176 kg/mt
	34-10905-10906	KASA PROF L FRAME PROFILE	136,10 cm <sup>4</sup>	130,82 cm <sup>4</sup>	3,763 kg/mt
	34-10921-10922	KASA PROF L FRAME PROFILE	108,20 cm <sup>4</sup>	63,63 cm <sup>4</sup>	3,075 kg/mt
	34-10911-10912	ORTA KAYIT PROF L MULLION PROFILE	71,24 cm <sup>4</sup>	15,33 cm <sup>4</sup>	2,136 kg/mt
	34-10909-10910	ORTA KAYIT PROF L MULLION PROFILE	84,16 cm <sup>4</sup>	66,01 cm <sup>4</sup>	3,038 kg/mt
	34-10913-10914	KANAT PROF L SASH PROFILE	85,68 cm <sup>4</sup>	24,23 cm <sup>4</sup>	2,446 kg/mt
	34-10915-10916	DI A AÇILIR KANAT PROF L OUTWARD OPENING SASH PROFILE	84,26 cm <sup>4</sup>	50,76 cm <sup>4</sup>	2,515 kg/mt
	34-10919-10920	ADAPTÖR PROF L ADAPTER PROFILE	-	-	1,956 kg/mt
	18-10917-10918	DI A AÇILIR ADAPTÖR PROF L OUTWARD OPENING ADAPTER PROFILE	-	-	1,914 kg/mt
	175	MENFEZ PROF L VENT PROFILE	-	-	0,345 kg/mt
	4904	MENFEZ PROF L VENT PROFILE	-	-	0,264 kg/mt
	10923	KANAT ALTI KAPAMA PROF L SUP-SASH COVER PROFILE	-	-	0,295 kg/mt
	2819	KASA K L T PROF L ADAPTER PROFILE	-	-	0,093 kg/mt
	8241	T J PROF L STEM BAR PROFILE	-	-	0,099 kg/mt
	3537	CAM ÇITASI (41,5 mm) GLAZING BEAD	-	-	0,367 kg/mt
	1750	CAM ÇITASI (38,5 mm) GLAZING BEAD	-	-	0,342 kg/mt
	1749	CAM ÇITASI (38,5 mm) GLAZING BEAD	-	-	0,356 kg/mt
	1747	CAM ÇITASI (34,5 mm) GLAZING BEAD	-	-	0,340 kg/mt
	1748	CAM ÇITASI (34,5 mm) GLAZING BEAD	-	-	0,327 kg/mt
	3536	CAM ÇITASI (31,5 mm) GLAZING BEAD	-	-	0,329 kg/mt

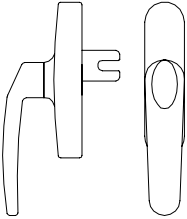
PROF L KES T PROFILE SECTION	PROF L KODU PROFILE CODE	PROF L ADI PROFILE NAME	Jx cm <sup>4</sup>	Jy cm <sup>4</sup>	A IRLIK (kg/m) WEIGHT
	3636	CAM ÇITASI (29,5 mm) GLAZING BEAD	-	-	0,321 kg/mt
	1966	CAM ÇITASI (27,5 mm) GLAZING BEAD	-	-	0,314 kg/mt
	2236	CAM ÇITASI (26,5 mm) GLAZING BEAD	-	-	0,310 kg/mt
	1949	CAM ÇITASI (25,5 mm) GLAZING BEAD	-	-	0,306 kg/mt
	1745	CAM ÇITASI (21,5 mm) GLAZING BEAD	-	-	0,292 kg/mt
	1699	CAM ÇITASI (19,5 mm) GLAZING BEAD	-	-	0,285 kg/mt
	3539	CAM ÇITASI (17 mm) GLAZING BEAD	-	-	0,277 kg/mt
	1698	CAM ÇITASI (13,5 mm) GLAZING BEAD	-	-	0,253 kg/mt
	3546	KÖ E TAKOZ PROF L CORNER WEDGE PROFILE	-	-	3,357 kg/mt
	1662	KÖ E TAKOZ PROF L CORNER WEDGE PROFILE	-	-	2,576 kg/mt
	3088	KÖ E TAKOZ PROF L CORNER WEDGE PROFILE	-	-	2,608 kg/mt
	7022	KÖ E TAKOZ PROF L CORNER WEDGE PROFILE	-	-	3,952 kg/mt
	597	KÖ E TAKOZ PROF L CORNER WEDGE PROFILE	-	-	4,241 kg/mt
	3547	KÖ E TAKOZ PROF L CORNER WEDGE PROFILE	-	-	4,884 kg/mt
	1398	KÖ E TAKOZ PROF L CORNER WEDGE PROFILE	-	-	5,089 kg/mt
	410	KÖ E TAKOZ PROF L CORNER WEDGE PROFILE	-	-	6,094 kg/mt

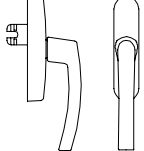
AKSESUAR ACCESSORY	STOK KODU REFERENCE CODE	AKSESUAR ADI DESCRIPTION	AKSESUAR KODU PRODUCT CODE	PAKET PACK
	03 010503	DI CAM F T L (EPDM) OUTER GLAZING GASKET	WD86T-DCF.30	215 mt / paket 10 kg/mt
	03 011230	Ç CAM F T L (EPDM) INNER GLAZING GASKET	WD86T- CF.30	330 mt / paket 10 kg/mt
	03 011231	Ç CAM F T L (EPDM) INNER GLAZING GASKET	WD86T- CF.40	205 mt / paket 10 kg/mt
	03 010732	Ç CAM F T L (EPDM) INNER GLAZING GASKET	WD86T- CF.50	175 mt / paket 10 kg/mt
	03 010621	B N F T L (EPDM) GASKET	WD86T-KBF.55	295 mt / paket 10 kg/mt
	03 010445	B N F T L (EPDM) GASKET	WD86T-KBF.30	270 mt / paket 10 kg/mt
	03 011029	ORTA B N F T L (EPDM) GASKET	WD86T-OBF.34	63 mt / paket 10 kg/mt
	03 010777	DI CAM F T L (EPDM) OUTER GLAZING GASKET	WD86T-CF.80	92 mt / paket 10 kg/mt
	01 130314	KÖ E ÇAVU U CORNER CONNECTION	WD86T-FJ.314	1 pk / 250 ad
	01 120201	AYARLI SPANYOLET KAR ILI I (SETSKURLU) ESPAGNOLETTE (PINNED)	WD86T-TPK.201	1 pk /100 adet
	01 120200	AYARLI SPANYOLET KAR ILI I (V DALI) ESPAGNOLETTE (SCREWED)	WD86T-TPK.200	1 pk /100 adet
	01 120100	SPANYOLET P M ESPAGNOLETTE PIN	WD86T-TP.100	1 pk /100 adet
	05 010401	153/35 D LL K L T BOLT LOCK	WD86T-DK.401	1 pk / 30 ad
	05 010405	155/35 MAKARALI K L T ROLLED LOCK	WD86T-MK.405	1 pk / 30 ad
	05 011106	96 MM BAREL(AS METR K) 96 MM CYLINDER(ASYMMETRIC)	WD86T-BR.106	1 pk / 24 ad
	01 060210	OVAL SER K L T KAR ILI I(D LL ) OVAL SERIES LOCK STRIKER(BOLT)	WD86T-KK.210	1 pk / 50 ad

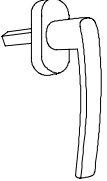
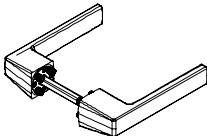
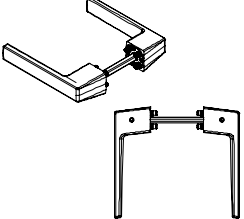
AKSESUAR ACCESSORY	STOK KODU REFERENCE CODE	AKSESUAR ADI DESCRIPTION	AKSESUAR KODU PRODUCT CODE	PAKET PACK
	01 060211	OVAL SER K L T KAR ILI I (MAKARALI) OVAL SERIES LOCK STRIKER(ROLLER)	WD86T-KK.211	1 pk / 50 ad
	04 010112	TAHL YE KAPA I DRAINAGE SLOT COVER	WD86T-TK.112	1 pk /100 ad
	01 150200	ALÜM NYUM KAPI ALTI FIRÇASI ALUMINIUM DOORBASE BRUSH	WD86T-KF.200	1 pk / 100 ad
	06 140210	CAM TAKOZU (5x28x80) GLAZING WEDGE 5 MM	WD86T-CT.210	1 pk /1000 ad
	06 140208	CAM TAKOZU (5x20x80) GLAZING WEDGE 5 MM	WD86T-CT.208	1 pk /1000 ad
	01 051101	U KOL (ELOKSALLI) U-SHAPED HANDLE (ANODIZED)	WD86T-UK.101	1 pk / 10 ad
	01 020810	FORZA EKSENEL KOL YEN (NATUREL) FORZA NEW AXIEL HANDLE (NATURAL)	WD86T-EK.810	1 pk /50 ad
	01 020811	FORZA EKSENEL KOL YEN (BEYAZ) FORZA NEW AXIEL HANDLE (WHITE)	WD86T-EK.811	1 pk /50 ad
	01 020812	FORZA EKSENEL KOL YEN (RENKL ) FORZA NEW AXIEL HANDLE (COLORED)	WD86T-EK.812	1 pk /50 ad
	01 020702	FORZA EKSENEL PENCERE KOL(BEYAZ) FORZA AXIAL WINDOW HANDLE(WHITE)	WD86T-FPK.702	1 pk /20 ad
	01 020703	FORZA EKSENEL PENCERE KOL(RENKL ) FORZA AXIAL WINDOW HANDLE(COLORED)	WD86T-FPK.703	1 pk /20 ad
	01 020803	FORZA EKSENEL PENCERE KOL(NATUREL) FORZA AXIAL WINDOW HANDLE (NATURAL)	WD86T-FPK.803	1 pk /20 ad
	01 020601	EKSENEL KOL ROTO (ELOKSALLI) ROTO AXIAL HANDLE (ANODIZED)	WD86T-RK.601	1 pk /10 ad
	01 020604	EKSENEL KOL ROTO (ELOKSALLI K L TL ) ROTO AXIAL HANDLE (ANODIZED LOCKED)	WD86T-RK.604	1 pk /10 ad
	01 200291	ROTO SECUST K PENCERE KOLU ROTO WINDOW HANDLE	WD86T-RK.291	1 pk /20 adet
	01 011140	ALFA M N MAL ST PEN KOLU 7701 ALFA MINIMALIST WINDOW HANDLE	WD86T-SPK.140	1 pk /1 ad
		ALFA M N MAL ST KOL ALFA MINIMAL HANDLE	H777771	

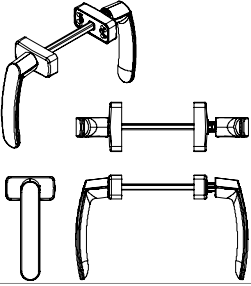
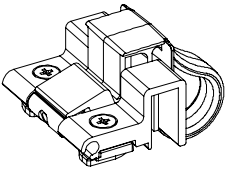
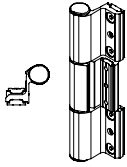
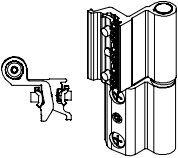
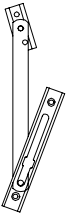
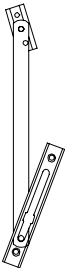
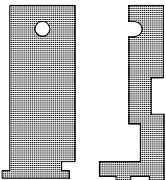
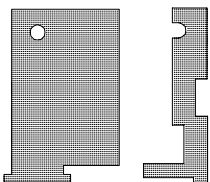
AKSESUAR ACCESSORY	STOK KODU REFERENCE CODE	AKSESUAR ADI DESCRIPTION	AKSESUAR KODU PRODUCT CODE	PAKET PACK
		SIRIUS YAYLI KOL SIRIUS HANDLE WITH SPRING	H77A05082	
	01 081702	S STEM AYARLI VAS STAS ÇARPMA(NATUREL) SYSTEM TRANSOM CATCH (NATURAL)	WD86T-VÇ.702	1 pk /100 ad
	01 081703	S STEM AYARLI VAS STAS ÇARPMA(BEYAZ) SYSTEM TRANSOM CATCH (WHITE)	WD86T-VÇ.703	1 pk /100 ad
	01 081704	S STEM AYARLI VAS STAS ÇARPMA(RENKL ) SYSTEM TRANSOM CATCH (COLORED)	WD86T-VÇ.704	1 pk /100 ad
	01 011137	P010D ACRUX KAPI MENTE ES ÜÇLÜ 160 KG (SA ) DOOR HINGE (RIGHT)	WD86T-KM.137	1 pk /10 ad
	01 011135	P010D ACRUX KAPI MENTE ES ÜÇLÜ 160 KG (SOL) DOOR HINGE (LEFT)	WD86T-KM.135	1 pk /10 ad
	01 011123	025D NORMA FAST PEN. MENTE E(S YAH) WINDOW HINGE (BLACK)	WD86T-PM.123	1 pk /10 ad
	01 011124	025D NORMA FAST MENTE E(BEYAZ) WINDOW HINGE (WHITE)	WD86T-PM.124	1 pk /10 ad
	01 080301	S STEM 13 CM VAS STAS MAKAS (ELOKSALLI) SYSTEM 13 CM TRANSOM TRUSS(ANODIZED)	WD86T-VM.301	1 pk /50 ad
	01 080302	S STEM 13 CM VAS STAS MAKAS (BEYAZ) SYSTEM 13 CM TRANSOM TRUSS(WHITE)	WD86T-VM.302	1 pk /50 ad
	01 080303	S STEM 13 CM VAS STAS MAKAS (RENKL ) SYSTEM 13 CM TRANSOM TRUSS(COLORED)	WD86T-VM.303	1 pk /50 ad
	01 080401	S STEM 22 CM VAS STAS MAKAS (ELOKSALLI) SYSTEM 22 CM TRANSOM TRUSS(ANODIZED)	WD86T-VM.401	1 pk /50 ad
	01 080402	S STEM 22 CM VAS STAS MAKAS (BEYAZ) SYSTEM 22 CM TRANSOM TRUSS(WHITE)	WD86T-VM.402	1 pk /50 ad
	01 080403	S STEM 22 CM VAS STAS MAKAS (RENKL ) SYSTEM 22 CM TRANSOM TRUSS(COLORED)	WD86T-VM.403	1 pk /50 ad
		D K BA LANTI VERTICAL CONNECTION	WD86T-DB.01/DB.02	
		D K BA LANTI VERTICAL CONNECTION	WD86T-DB.07/DB.08	



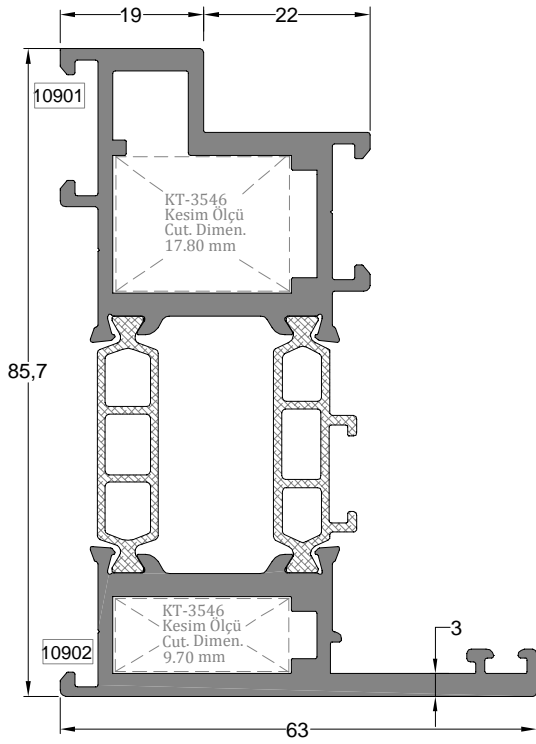

Kasa Profili FRAME PROFILE	Profil Kodu Profile Code	(kg/mt) Weight	Jx cm <sup>4</sup>	Jy cm <sup>4</sup>
	34-10901-10902	2,341	74,02	20,23

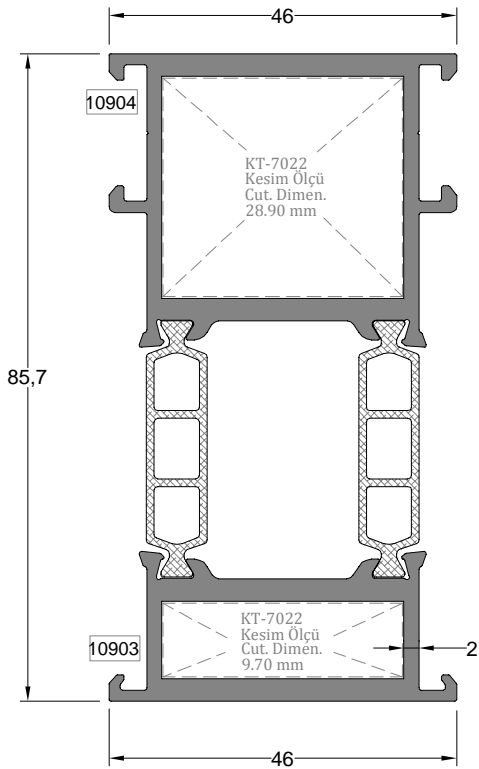

Kasa Profili FRAME PROFILE	Profil Kodu Profile Code	(kg/mt) Weight	Jx cm <sup>4</sup>	Jy cm <sup>4</sup>
	34-10903-10904	2,176	72,97	17,15

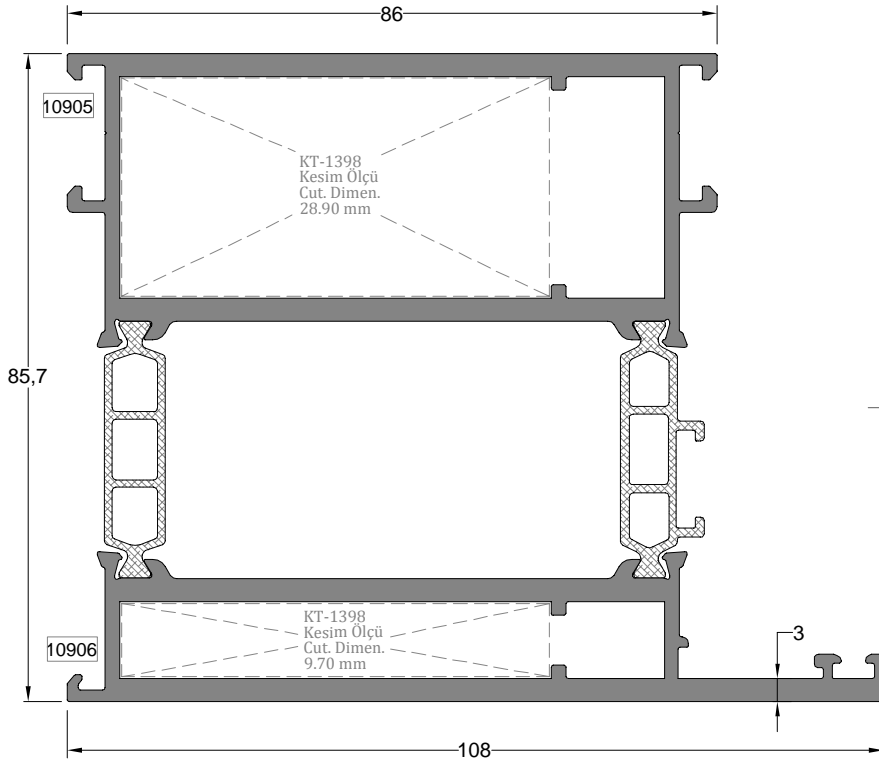

Kasa Profili	Profil Kodu	(kg/mt)	Jx cm <sup>4</sup>	Jy cm <sup>4</sup>
FRAME PROFILE	Profile Code	Weight		
	34-10905-10906	3,763	136,10	130,82

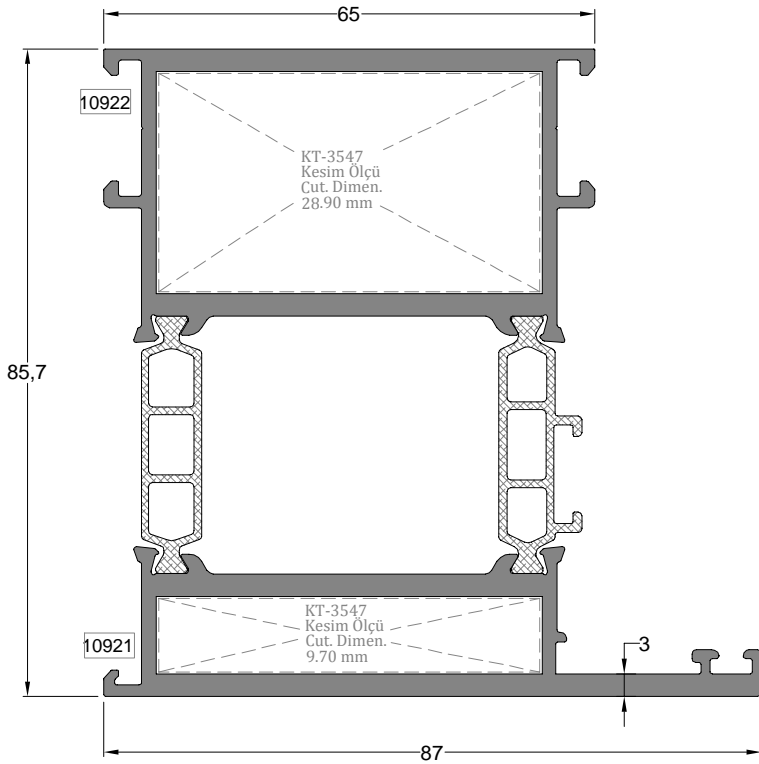

Kasa Profili	Profil Kodu	(kg/mt)	Jx cm <sup>4</sup>	Jy cm <sup>4</sup>
FRAME PROFILE	Profile Code	Weight		
	34-10921-10922	3,075	108,20	63,63

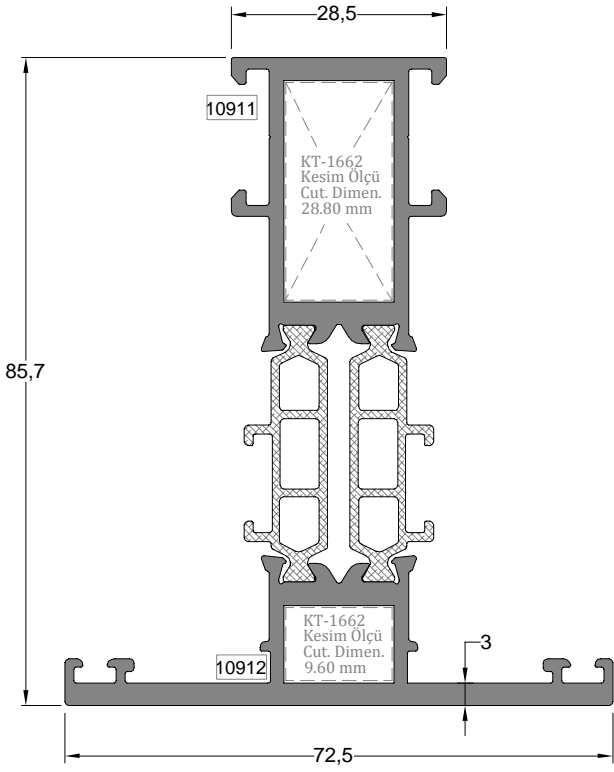

Orta Kayıt Profili	Profil Kodu	(kg/mt)	Jx cm <sup>4</sup>	Jy cm <sup>4</sup>
MULLION PROFILE	Profile Code	Weight		
	34-10911-10912	2,136	71,24	15,33

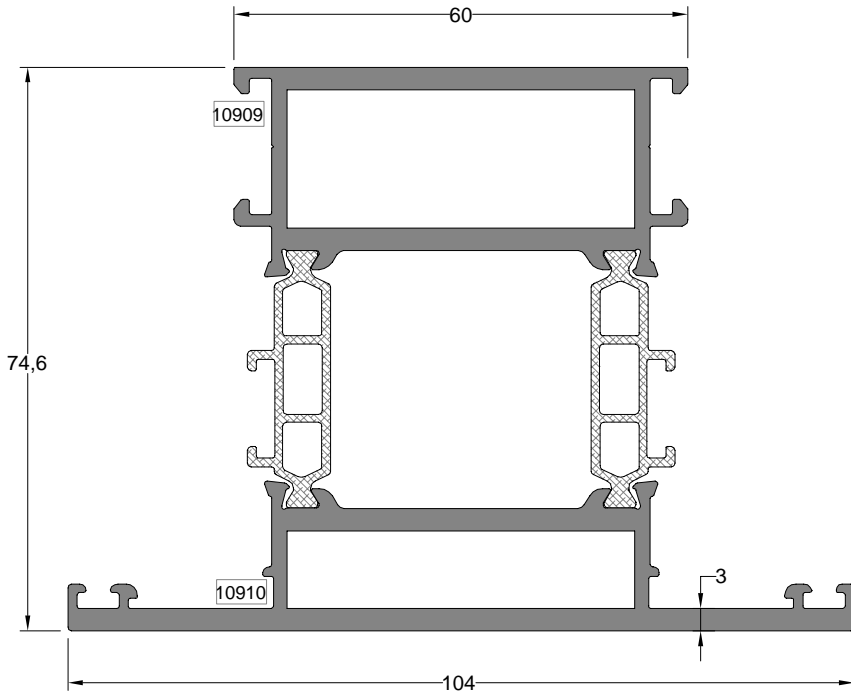

Orta Kayıt Profili	Profil Kodu	(kg/mt)	Jx cm <sup>4</sup>	Jy cm <sup>4</sup>
MULLION PROFILE	Profile Code	Weight		
	34-10909-10910	3,038	84,16	66,01

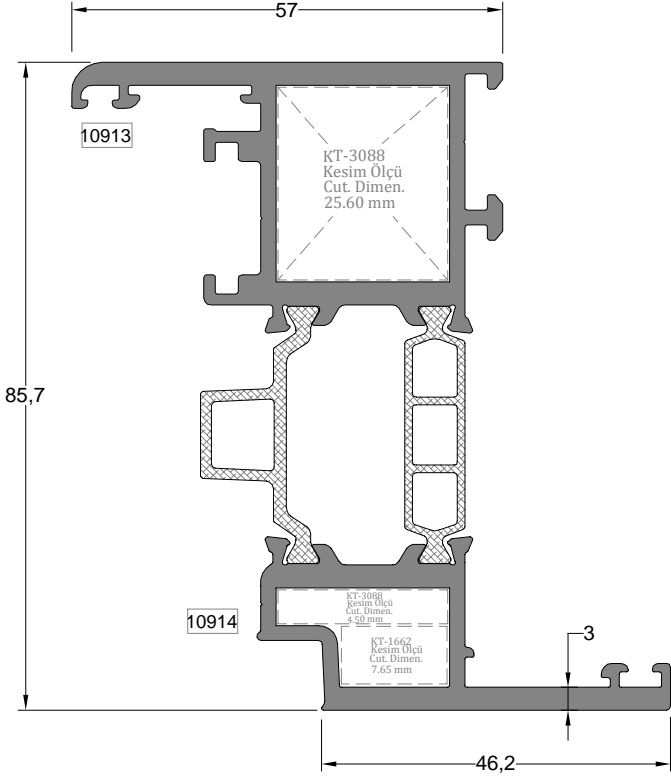

Kanat Profili	Profil Kodu	(kg/mt)	Jx cm <sup>4</sup>	Jy cm <sup>4</sup>
SASH PROFILE	Profile Code	Weight		
	34-10913-10914	2,446	85,68	24,23

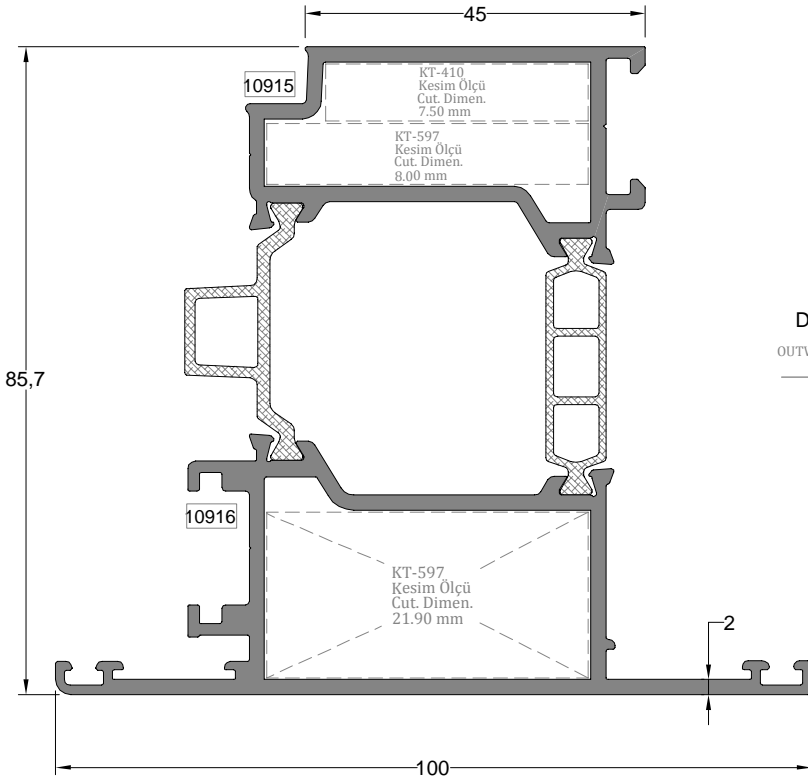

Dışarı Açılır Kanat Profili	Profil Kodu	(kg/mt)	Jx cm <sup>4</sup>	Jy cm <sup>4</sup>
OUTWARD OPENING SASH PROFILE	Profile Code	Weight		
	34-10915-10916	2,515	84,26	50,76

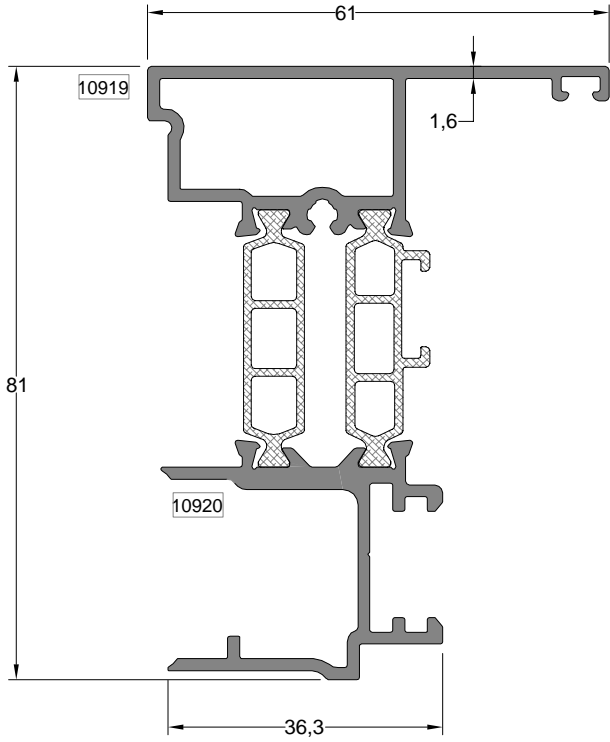

Adaptör Profili ADAPTER PROFILE	Profil Kodu Profile Code	(kg/mt) weight
	18-10919-10920	1,956

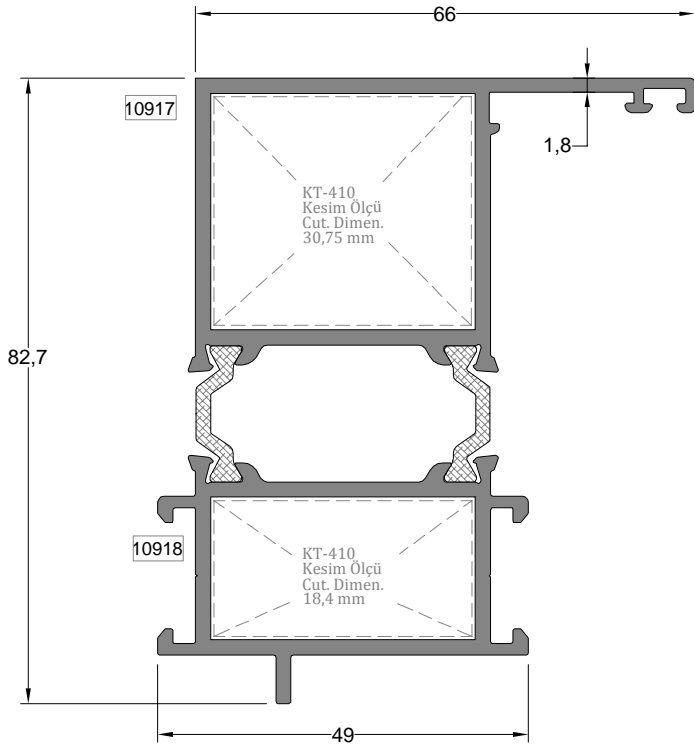

Dışa Açılır Adaptör Profili OUTWARD OPENING ADAPTER PROFILE	Profil Kodu Profile Code	(kg/mt) weight
	18-10917-10918	1,914

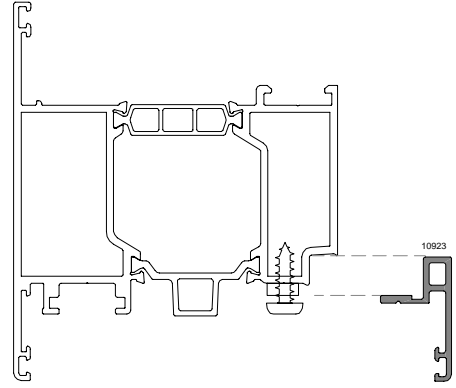
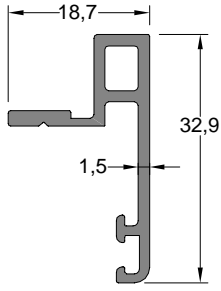

Kanat Altı Kapama Profili SUB-SASH COVER PROFILE	Profil Kodu Profile Code	(kg/mt) weight
	10923	0,295

ÖLÇEK 1/2

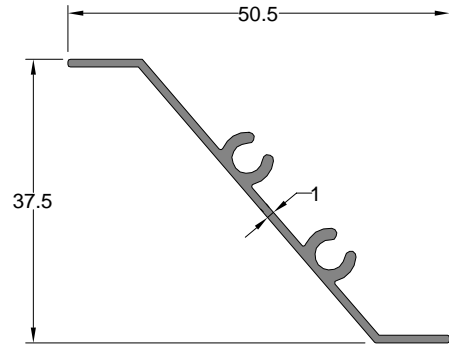
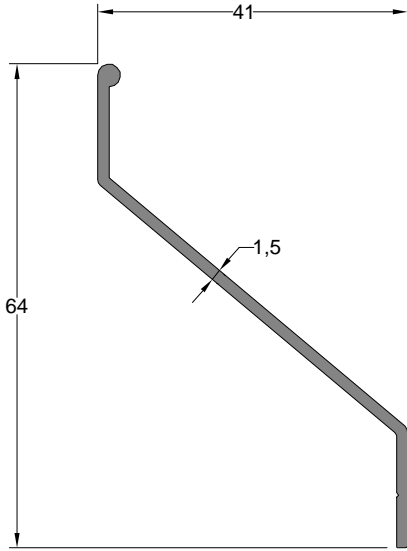

Menfez Profili VENT PROFILE	Profil Kodu Profile Code	(kg/mt) weight
	175	0,345

Menfez Profili VENT PROFILE	Profil Kodu Profile Code	(kg/mt) weight
	4904	0,264

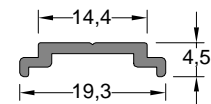
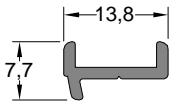

Kasa Kilit Profili ADAPTER PROFILE	Profil Kodu Profile Code	(kg/mt) weight
	2819	0,093

Tij Profili STEM BAR PROFILE	Profil Kodu Profile Code	(kg/mt) weight
	8241	0,099

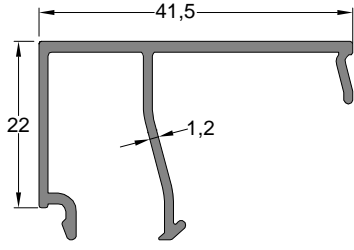

Cam Çıtası	Profil Kodu	(kg/mt)
GLAZING BEAD	Profile Code	weight
	3537	0,367

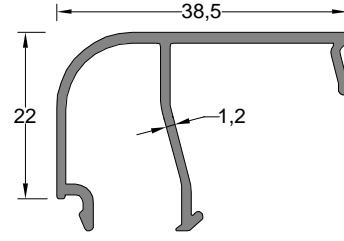

Cam Çıtası	Profil Kodu	(kg/mt)
GLAZING BEAD	Profile Code	weight
	1750	0,342

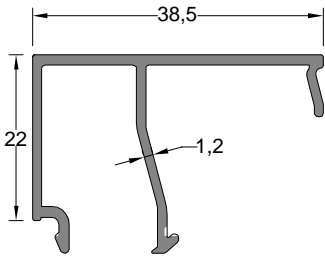

Cam Çıtası	Profil Kodu	(kg/mt)
GLAZING BEAD	Profile Code	weight
	1749	0,356

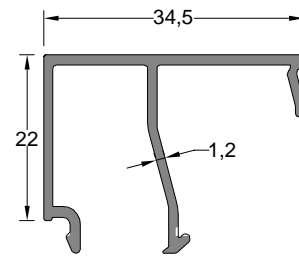

Cam Çıtası	Profil Kodu	(kg/mt)
GLAZING BEAD	Profile Code	weight
	1747	0,340

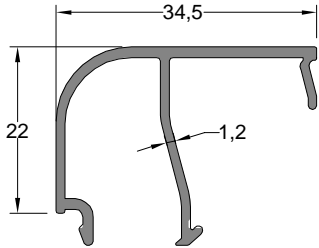

Cam Çıtası	Profil Kodu	(kg/mt)
GLAZING BEAD	Profile Code	weight
	1748	0,327

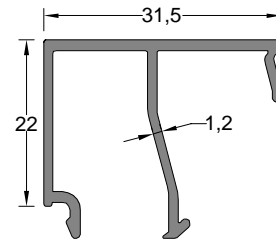

Cam Çıtası	Profil Kodu	(kg/mt)
GLAZING BEAD	Profile Code	weight
	3536	0,329

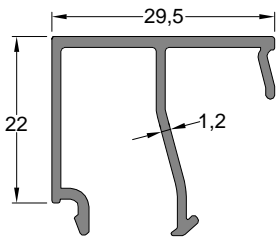

Cam Çıtası	Profil Kodu	(kg/mt)
GLAZING BEAD	Profile Code	weight
	3636	0,321

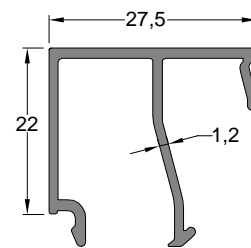

Cam Çıtası	Profil Kodu	(kg/mt)
GLAZING BEAD	Profile Code	weight
	1966	0,314

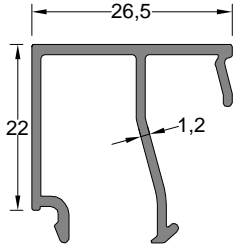

Cam Çıtası	Profil Kodu Profile Code	(kg/mt) weight
GLAZING BEAD	2236	0,310

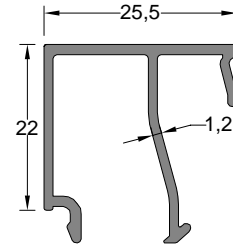

Cam Çıtası	Profil Kodu Profile Code	(kg/mt) weight
GLAZING BEAD	1949	0,306

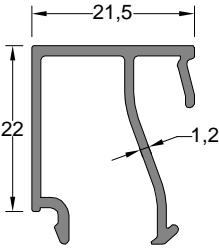

Cam Çıtası	Profil Kodu Profile Code	(kg/mt) weight
GLAZING BEAD	1745	0,292

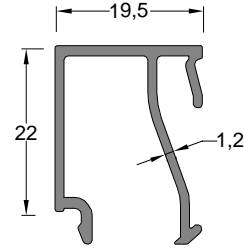

Cam Çıtası	Profil Kodu Profile Code	(kg/mt) weight
GLAZING BEAD	1699	0,285

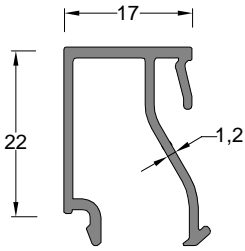

Cam Çıtası	Profil Kodu Profile Code	(kg/mt) weight
GLAZING BEAD	3539	0,277

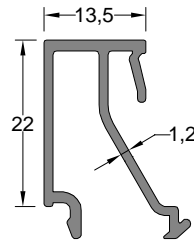

Cam Çıtası	Profil Kodu Profile Code	(kg/mt) weight
GLAZING BEAD	1698	0,253



CAM ÇITASI GLAZING BEAD <b>(G)</b>	CAM ÇITASI UZUNLU ĞU GLAZING BEAD LENGTH <b>(L)</b>	Ç CAM F T L GLAZING GASKET(inside) <b>(I)</b>	CAM KALINLI ĞI GLASS THICKNESS <b>(T)</b>	DI CAM F T L GLAZING GASKET(outside) <b>(O)</b>
3537	41,5 mm	CF.50	26 mm	CF.80
3537	41,5 mm	CF.40	27 mm	CF.80
3537	41,5 mm	CF.30	28 mm	CF.80
1750	38,5 mm	CF.50	29 mm	CF.80
1749	38,5 mm	CF.50	29 mm	CF.80
1750	38,5 mm	CF.40	30 mm	CF.80
1749	38,5 mm	CF.40	30 mm	CF.80
1750	38,5 mm	CF.30	31 mm	CF.80
1749	38,5 mm	CF.30	31 mm	CF.80
1747	34,5 mm	CF.50	33 mm	CF.80
1748	34,5 mm	CF.50	33 mm	CF.80
1747	34,5 mm	CF.40	34 mm	CF.80
1748	34,5 mm	CF.40	34 mm	CF.80
1747	34,5 mm	CF.30	35 mm	CF.80
1748	34,5 mm	CF.30	35 mm	CF.80
3536	31,5 mm	CF.50	36 mm	CF.80
3536	31,5 mm	CF.40	37 mm	CF.80
3636	29,5 mm	CF.50	37 mm	CF.80
3536	31,5 mm	CF.30	38 mm	CF.80
3636	29,5 mm	CF.40	38 mm	CF.80
3636	29,5 mm	CF.30	39 mm	CF.80

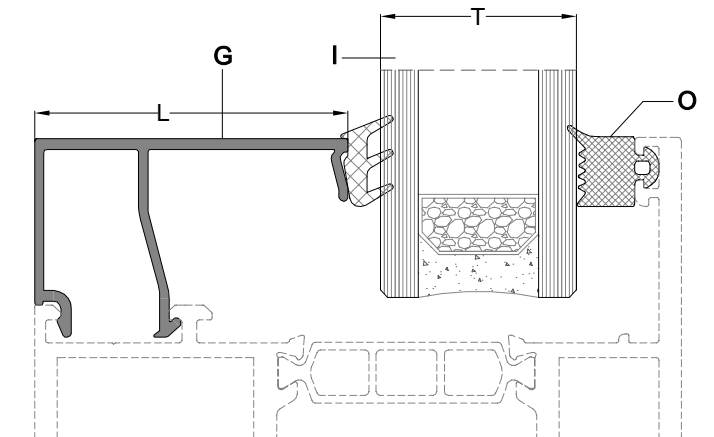

CAM ÇITASI GLAZING BEAD <b>(G)</b>	CAM ÇITASI UZUNLU Ğ GLAZING BEAD LENGTH <b>(L)</b>	Ç CAM F T L GLAZING GASKET(inside) <b>(I)</b>	CAM KALINLI Ğ GLASS THICKNESS <b>(T)</b>	DI CAM F T L GLAZING GASKET(outside) <b>(O)</b>
1966	27,5 mm	CF.50	39 mm	CF.80
1966	27,5 mm	CF.40	40 mm	CF.80
2236	26,5 mm	CF.50	40 mm	CF.80
1966	27,5 mm	CF.30	41 mm	CF.80
2236	26,5 mm	CF.40	41 mm	CF.80
1949	25,5 mm	CF.50	41 mm	CF.80
2236	26,5 mm	CF.30	42 mm	CF.80
1949	25,5 mm	CF.40	42 mm	CF.80
1949	25,5 mm	CF.30	43 mm	CF.80
1745	21,5 mm	CF.50	46 mm	CF.80
1745	21,5 mm	CF.40	47 mm	CF.80
1745	21,5 mm	CF.30	48 mm	CF.80
1699	19,5 mm	CF.50	48 mm	CF.80
1699	19,5 mm	CF.40	49 mm	CF.80
1699	19,5 mm	CF.30	50 mm	CF.80
3539	17 mm	CF.50	50 mm	CF.80
3539	17 mm	CF.40	51 mm	CF.80
3539	17 mm	CF.30	52 mm	CF.80
1698	13,5 mm	CF.50	53 mm	CF.80
1698	13,5 mm	CF.40	54 mm	CF.80
1698	13,5 mm	CF.30	55 mm	CF.80
1698	13,5 mm	CF.30	56 mm	CF.80

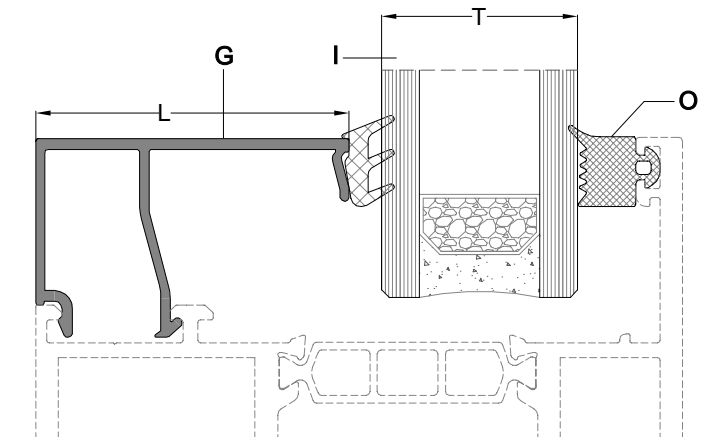

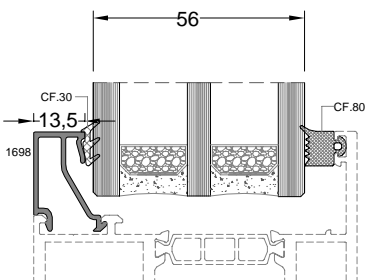
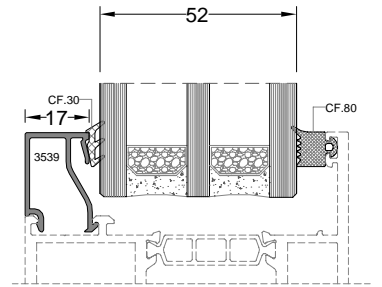
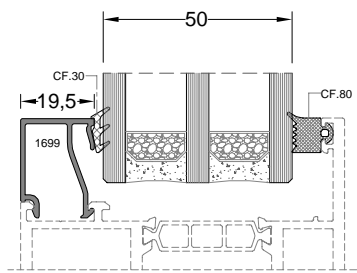
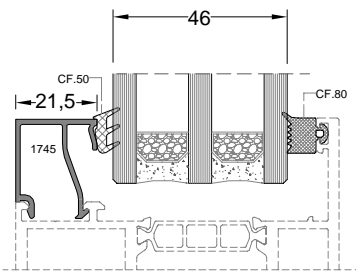
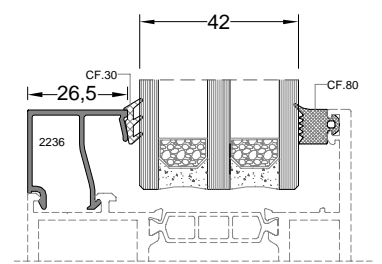
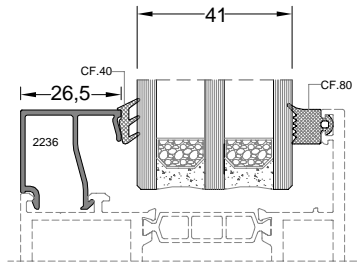
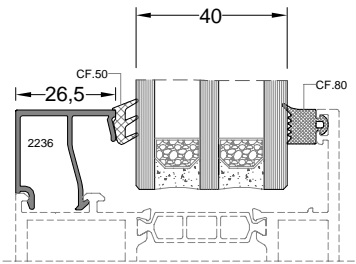
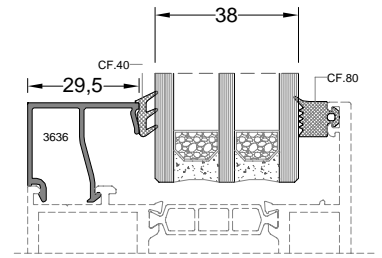
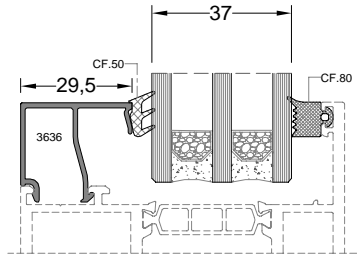
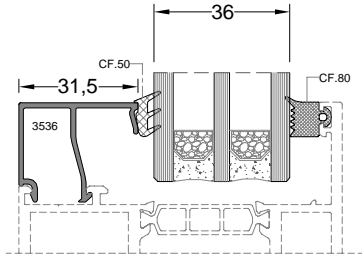
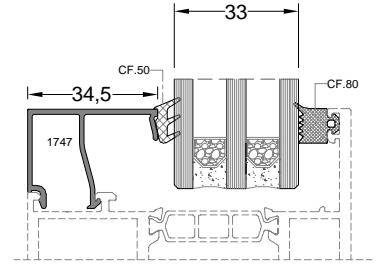
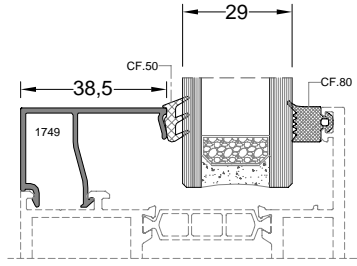
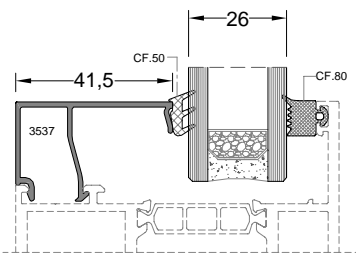

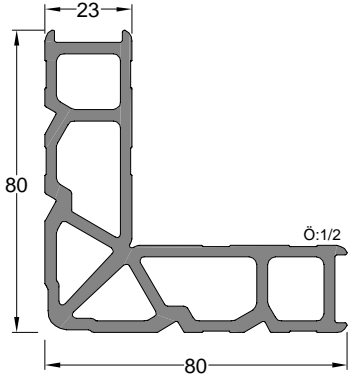

Kö e Takozu Profil Kodu Corner Wedge Profile Code	Kullanıldı ı Profil Compatible Profile	Kesim Boyu (mm) Cutting Length (mm)
3546	10901	17,80 mm
	10902	9,70 mm

Kö e Takoz Profili CORNER WEDGE PROFILE	Profil Kodu Profile Code	(kg/mt) weight
	3546	3,357

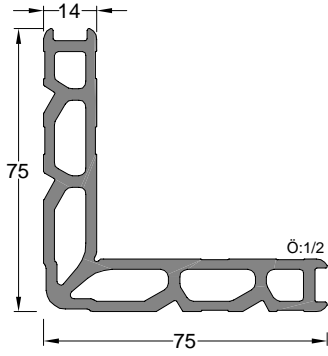

Kö e Takozu Profil Kodu Corner Wedge Profile Code	Kullanıldı ı Profil Compatible Profile	Kesim Boyu (mm) Cutting Length (mm)
1662	10911	28,80 mm
	10912	9,60 mm
	10914	7,65 mm

Kö e Takoz Profili CORNER WEDGE PROFILE	Profil Kodu Profile Code	(kg/mt) weight
	1662	2,576

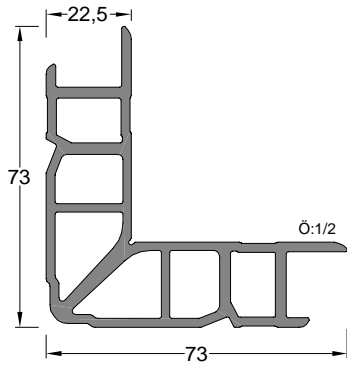

Kö e Takozu Profil Kodu Corner Wedge Profile Code	Kullanıldı ı Profil Compatible Profile	Kesim Boyu (mm) Cutting Length (mm)
3088	10913	25,60 mm
	10914	7,65 mm
	10914	4,50 mm

Kö e Takoz Profili CORNER WEDGE PROFILE	Profil Kodu Profile Code	(kg/mt) weight
	3088	2,608

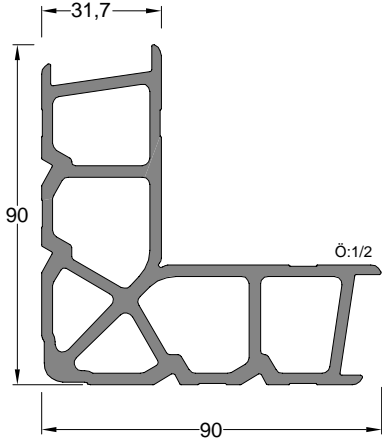

Kö e Takozu Profil Kodu Corner Wedge Profile Code	Kullanıldığı Profil Compatible Profile	Kesim Boyu (mm) Cutting Length (mm)
7022	10903	9,70 mm
	10904	28,90 mm

Kö e Takoz Profili CORNER WEDGE PROFILE	Profil Kodu Profile Code	(kg/mt) weight
	7022	3,952

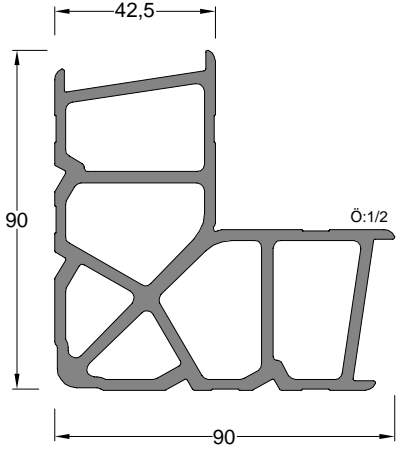

Kö e Takozu Profil Kodu Corner Wedge Profile Code	Kullanıldığı Profil Compatible Profile	Kesim Boyu (mm) Cutting Length (mm)
597	10915	8,00 mm
	10916	21,90 mm

Kö e Takoz Profili CORNER WEDGE PROFILE	Profil Kodu Profile Code	(kg/mt) weight
	597	4,241

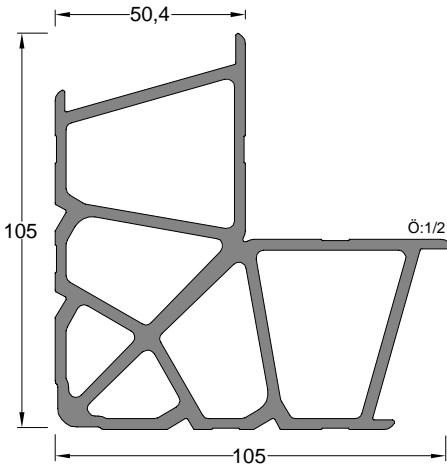

Kö e Takozu Profil Kodu Corner Wedge Profile Code	Kullanıldığı Profil Compatible Profile	Kesim Boyu (mm) Cutting Length (mm)
3547	10921	9,70 mm
	10922	28,90 mm

Kö e Takoz Profili CORNER WEDGE PROFILE	Profil Kodu Profile Code	(kg/mt) weight
	3547	4,884

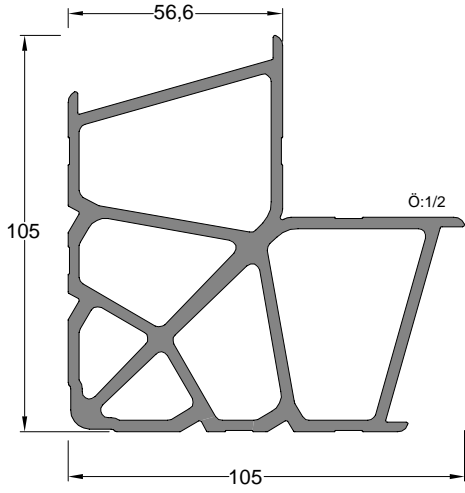

Kö e Takozu Profil Kodu Corner Wedge Profile Code	Kullanıldı ı Profil Compatible Profile	Kesim Boyu (mm) Cutting Length (mm)
1398	10905	28,90 mm
	10906	9,70 mm

Kö e Takoz Profili CORNER WEDGE PROFILE	Profil Kodu Profile Code	(kg/mt) weight
	1398	5,089

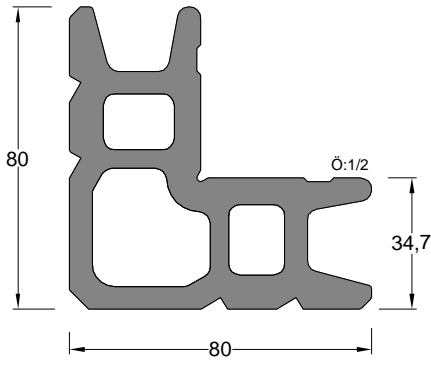

Kö e Takozu Profil Kodu Corner Wedge Profile Code	Kullanıldı ı Profil Compatible Profile	Kesim Boyu (mm) Cutting Length (mm)
410	10915	7,50 mm
	10917	30,75 mm
	10918	18,40 mm

Kö e Takoz Profili CORNER WEDGE PROFILE	Profil Kodu Profile Code	(kg/mt) weight
	410	6,094

GEN ORTA KAYIT DETAYI

DAR ORTA KAYIT DETAYI

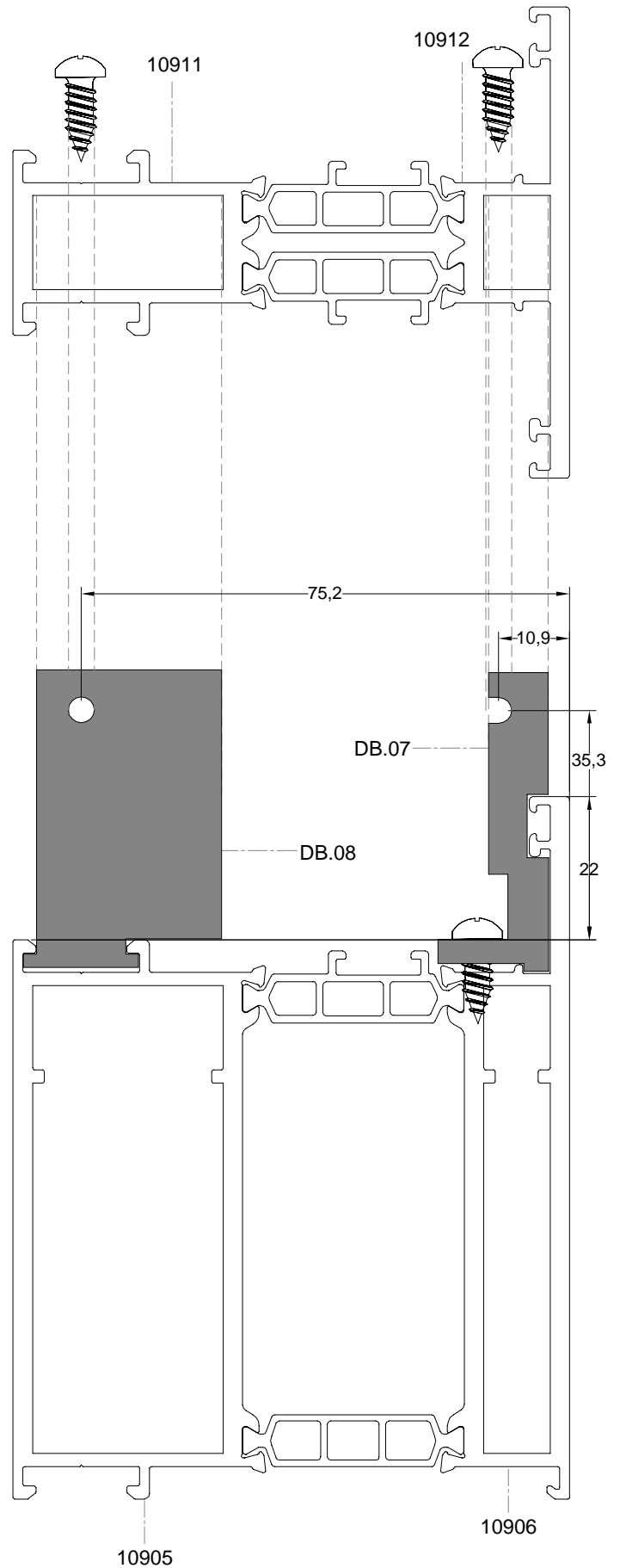
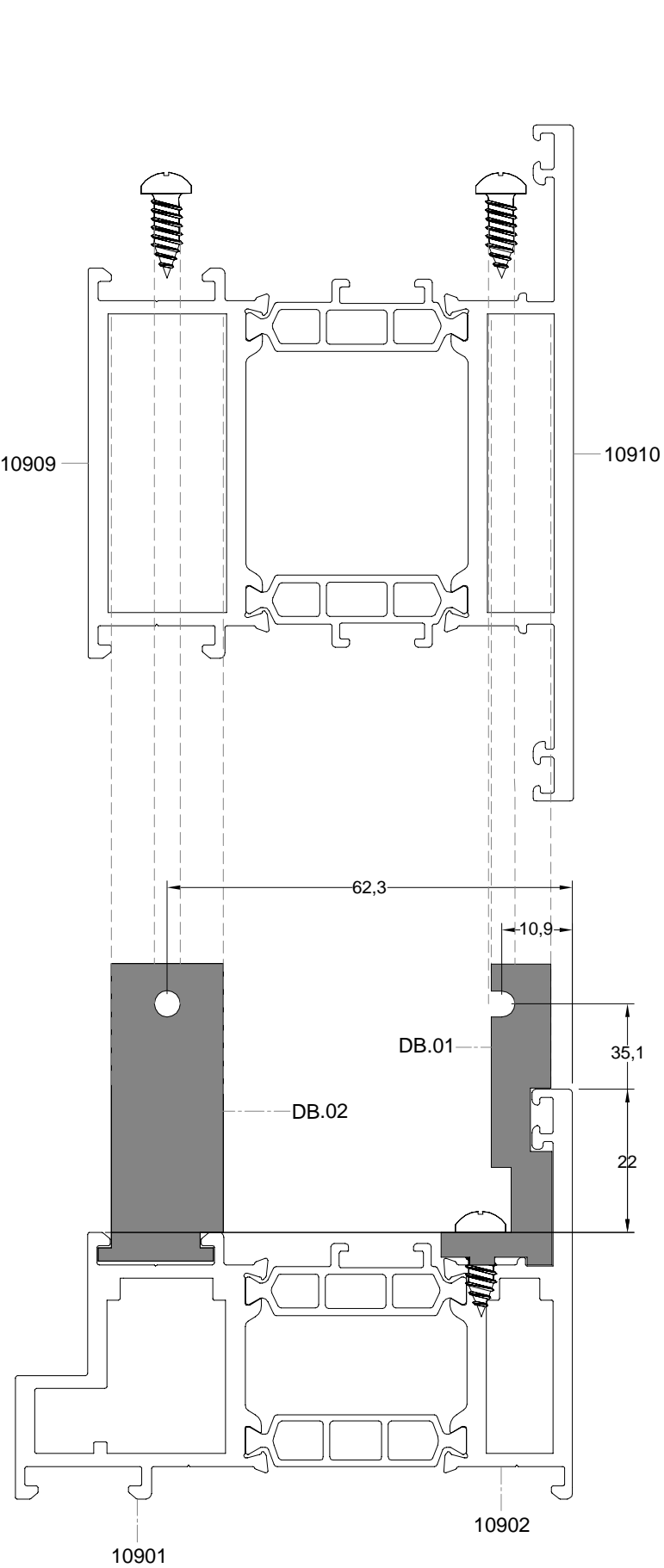

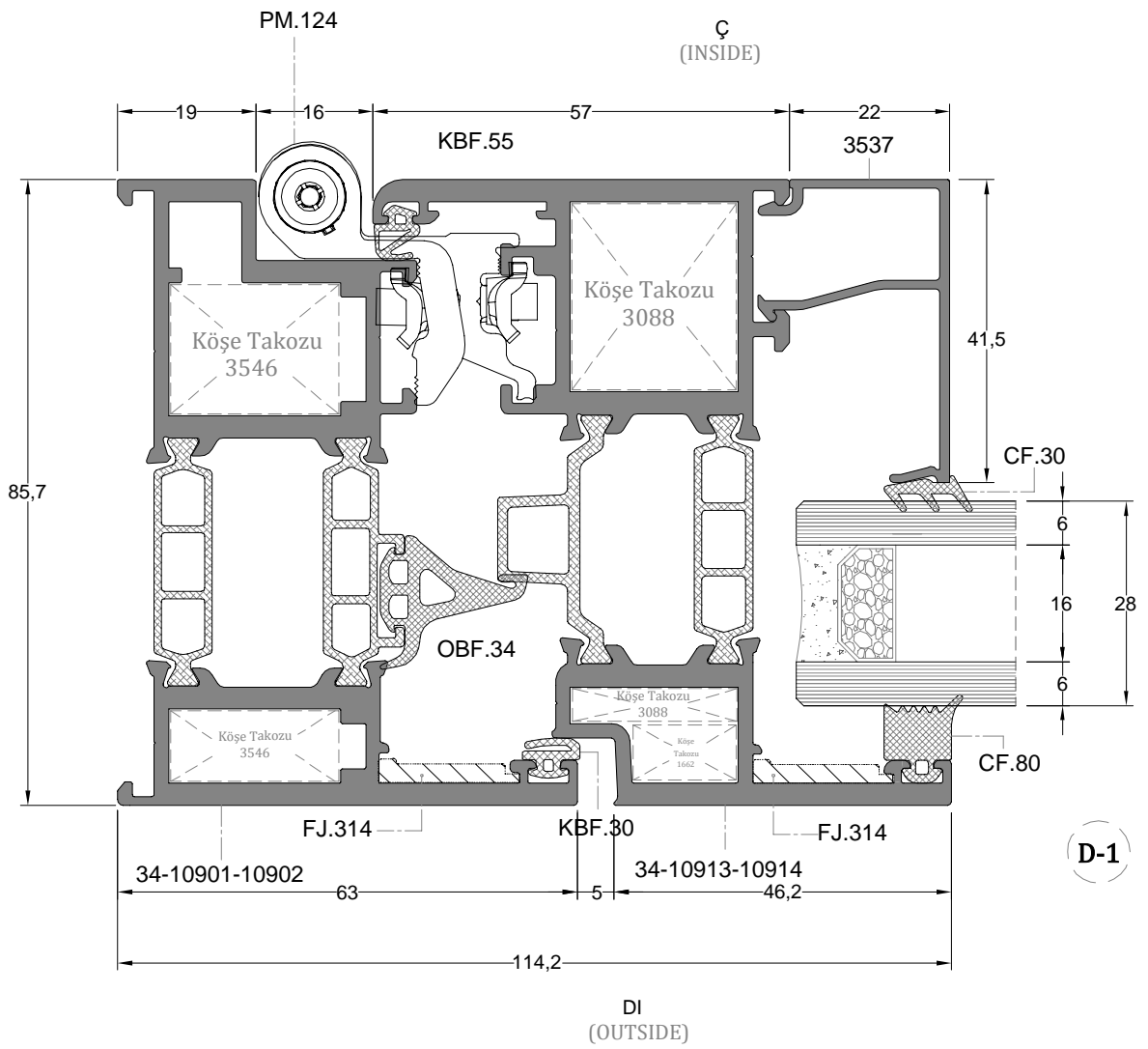
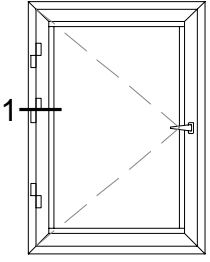



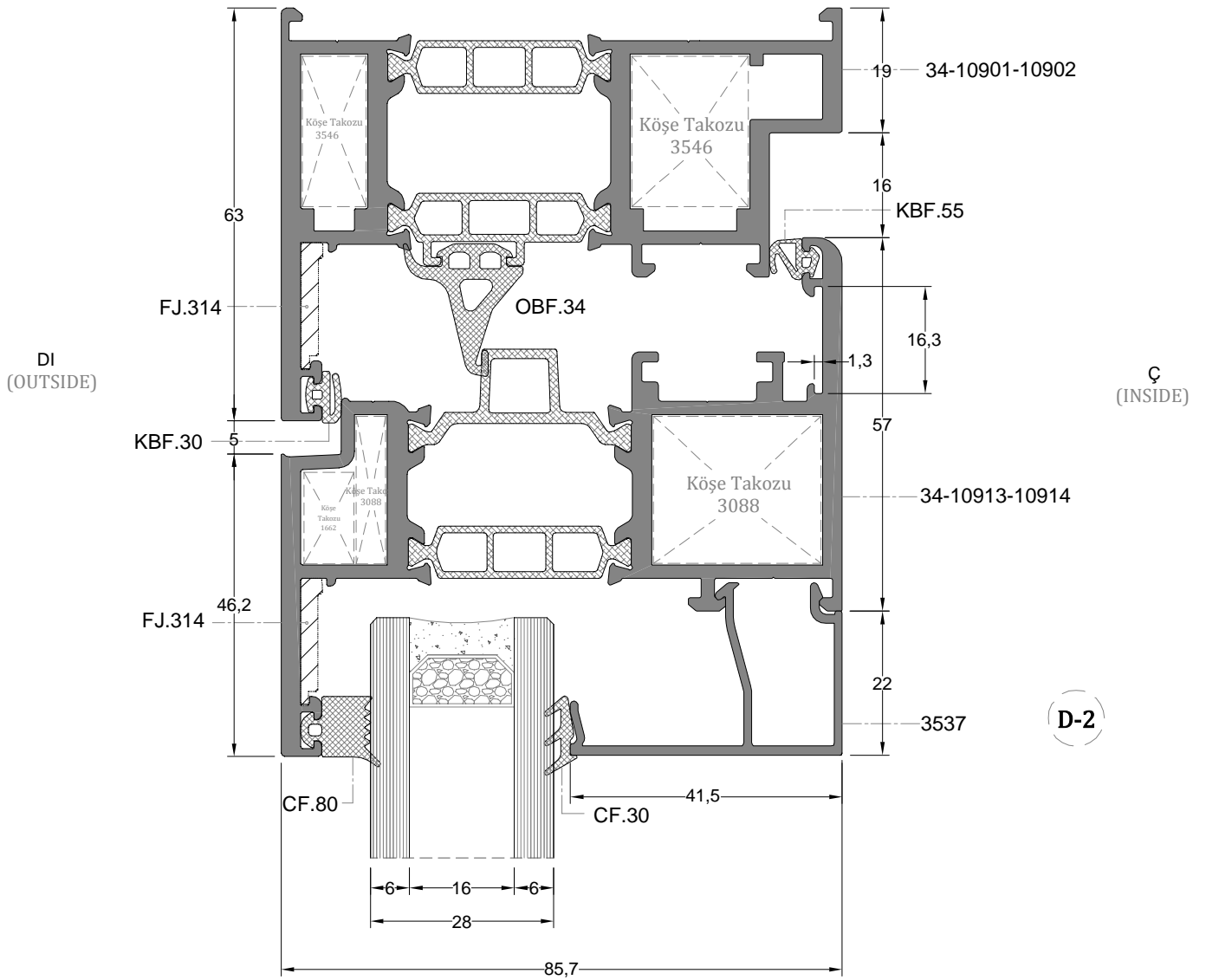
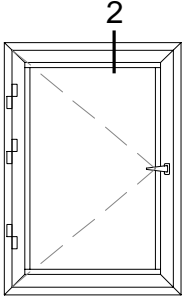

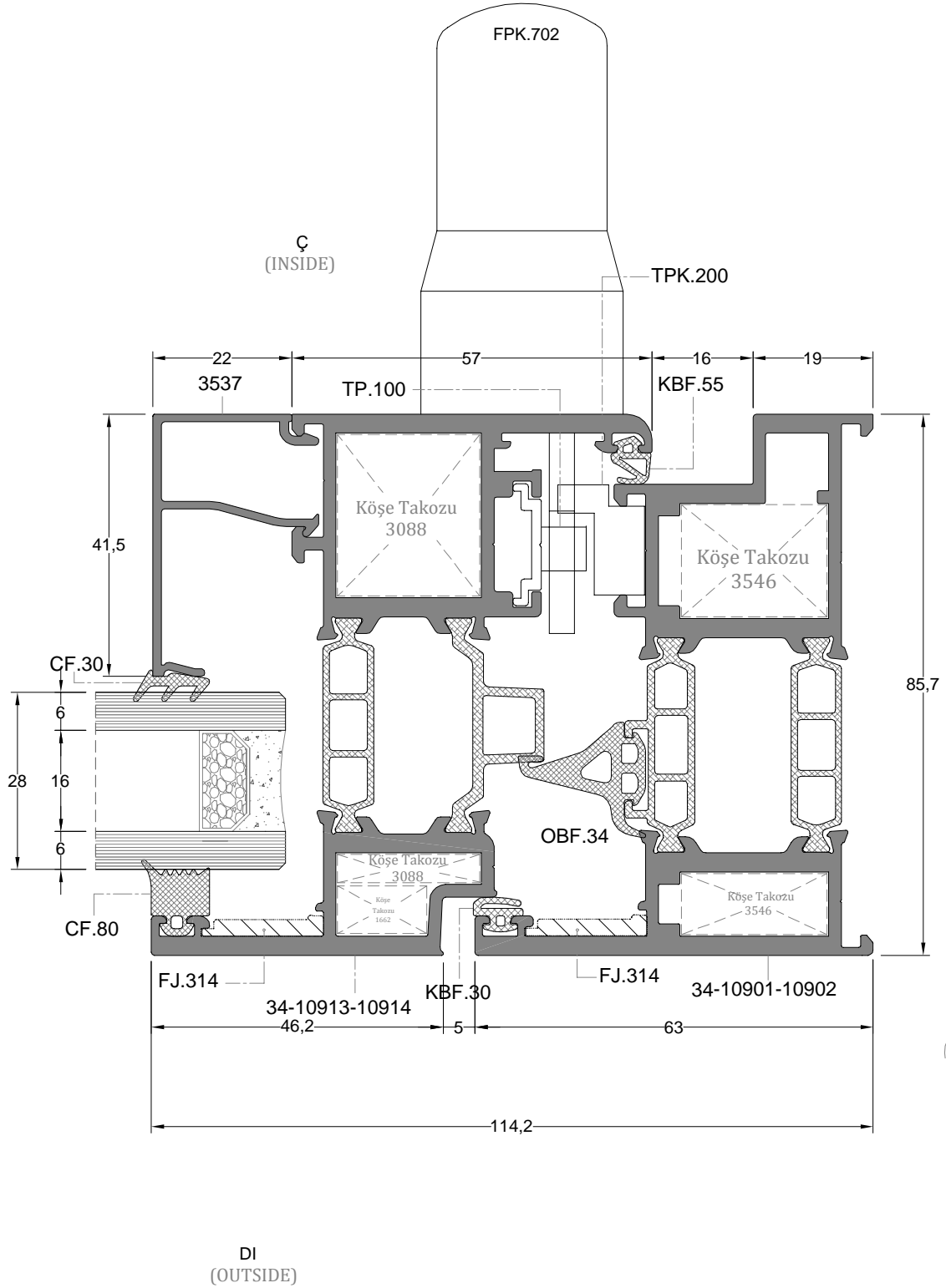
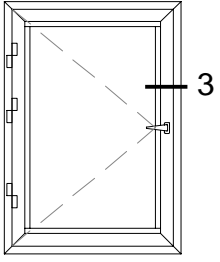

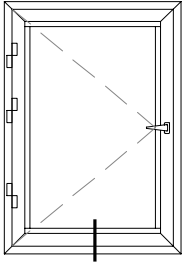

4

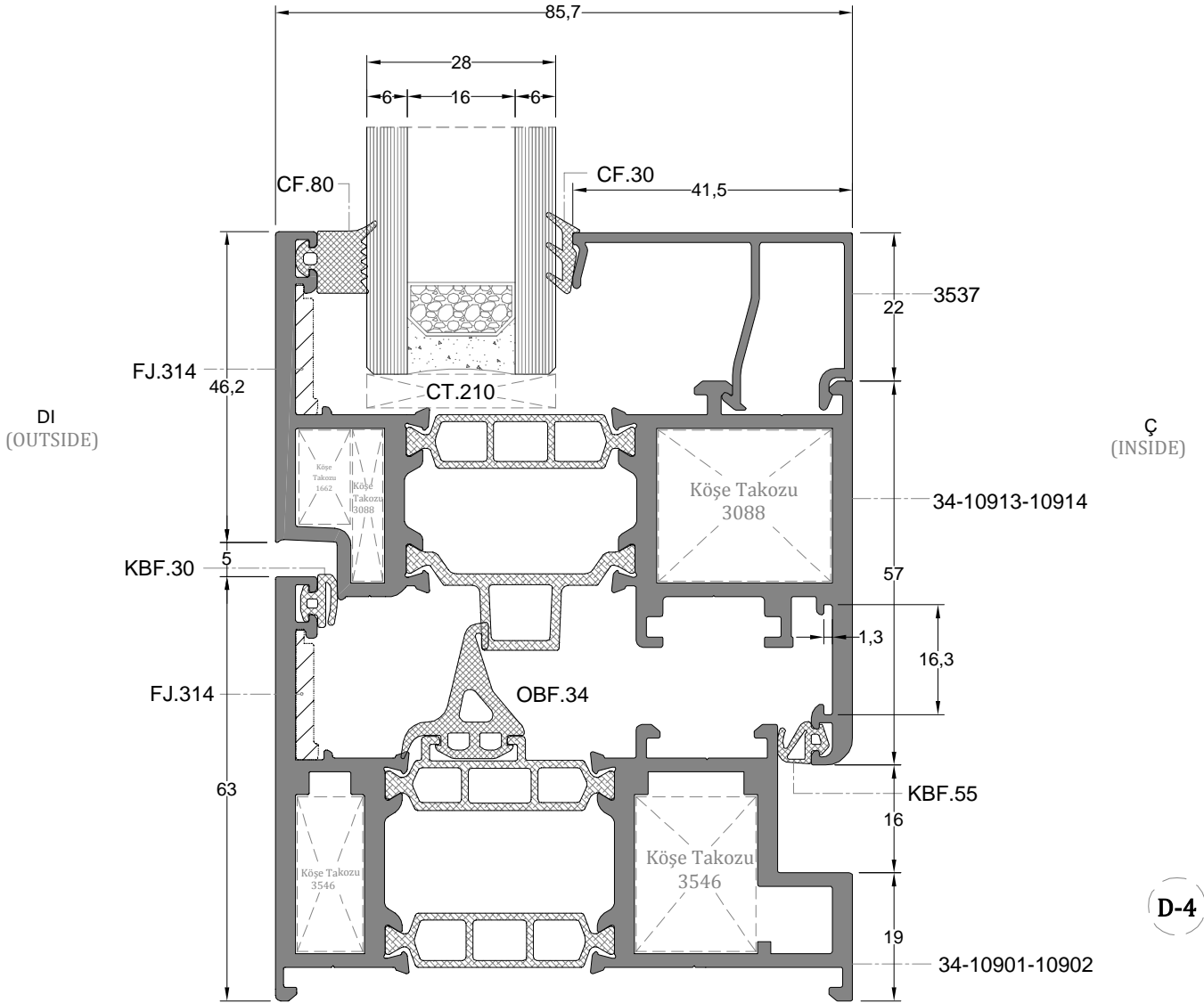

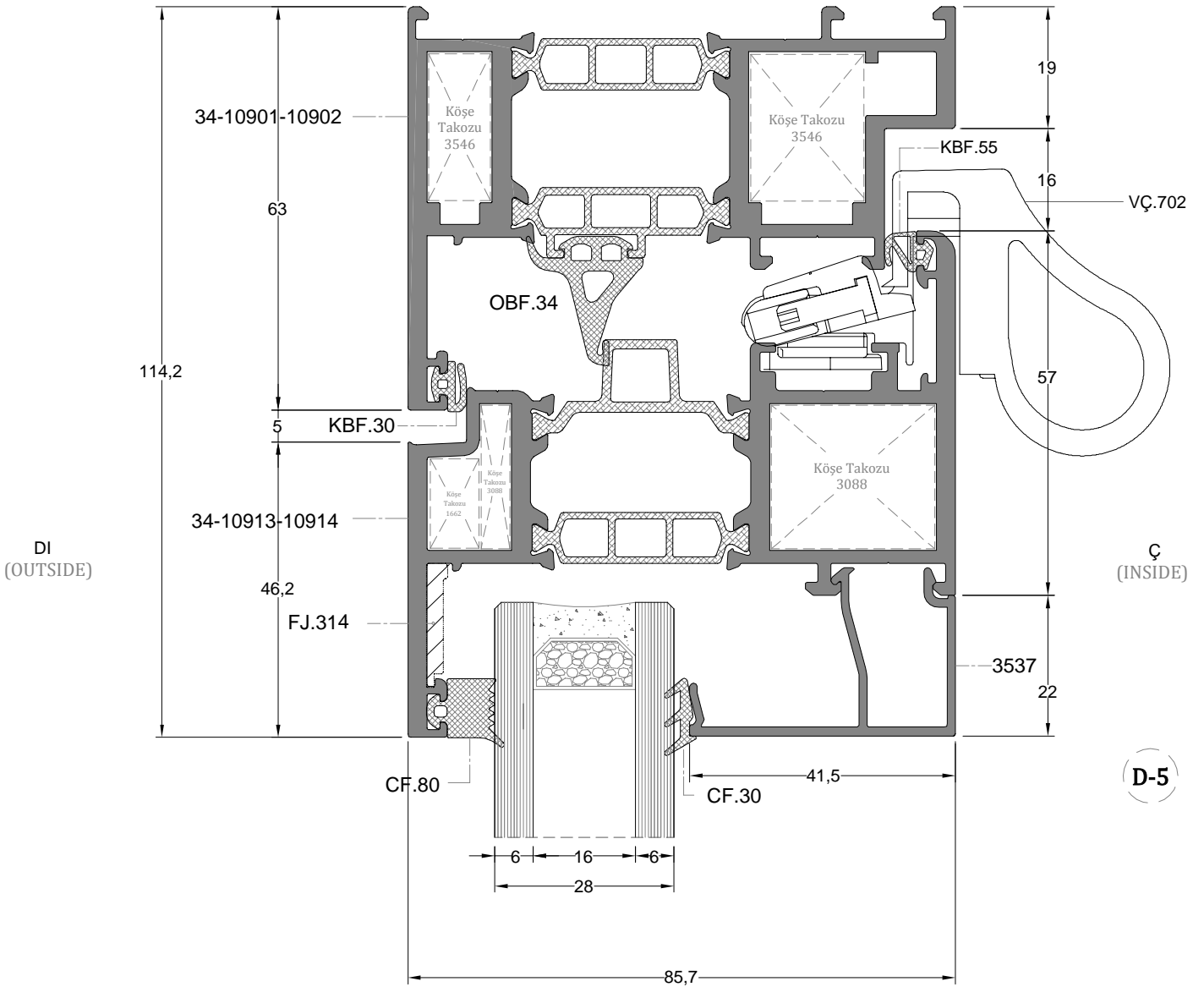
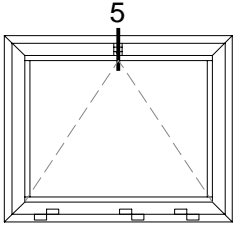

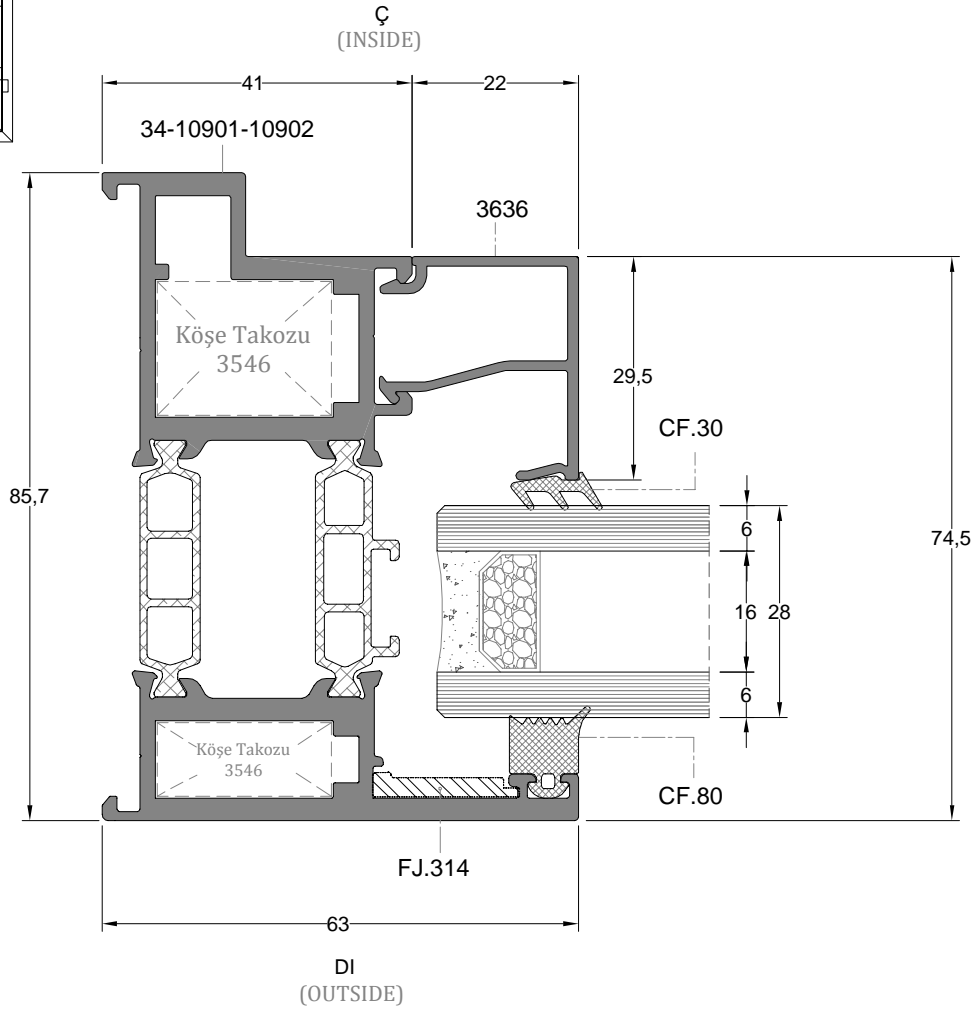
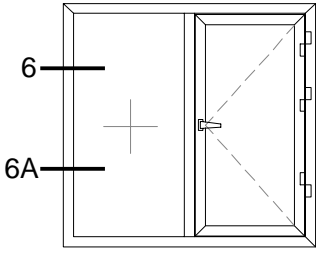

D-6

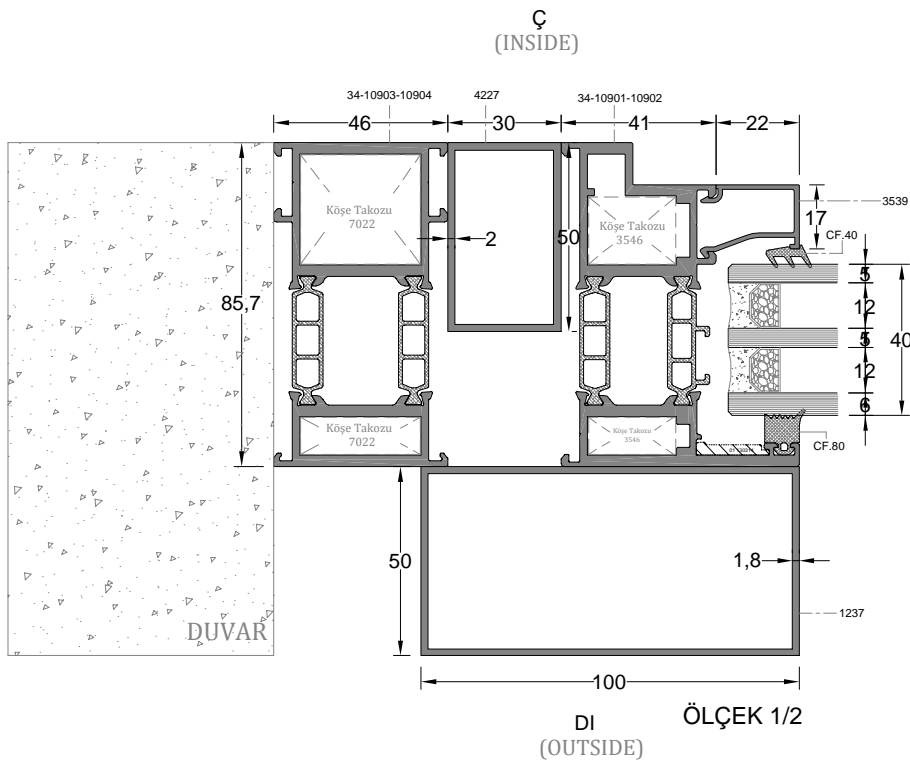

D-6A

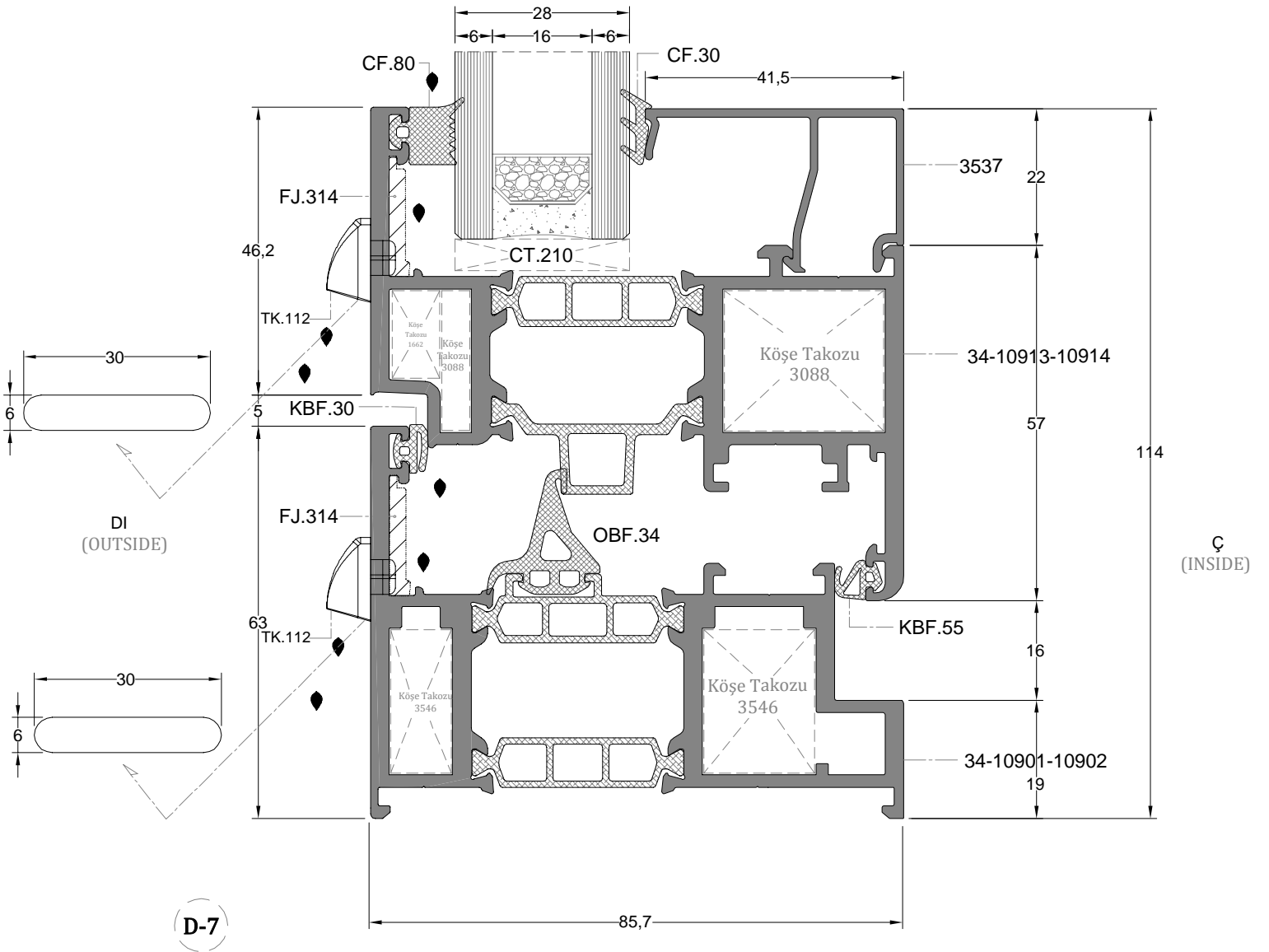
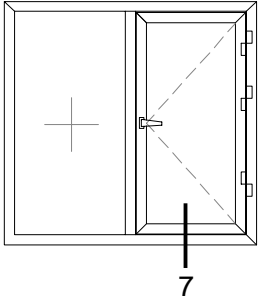

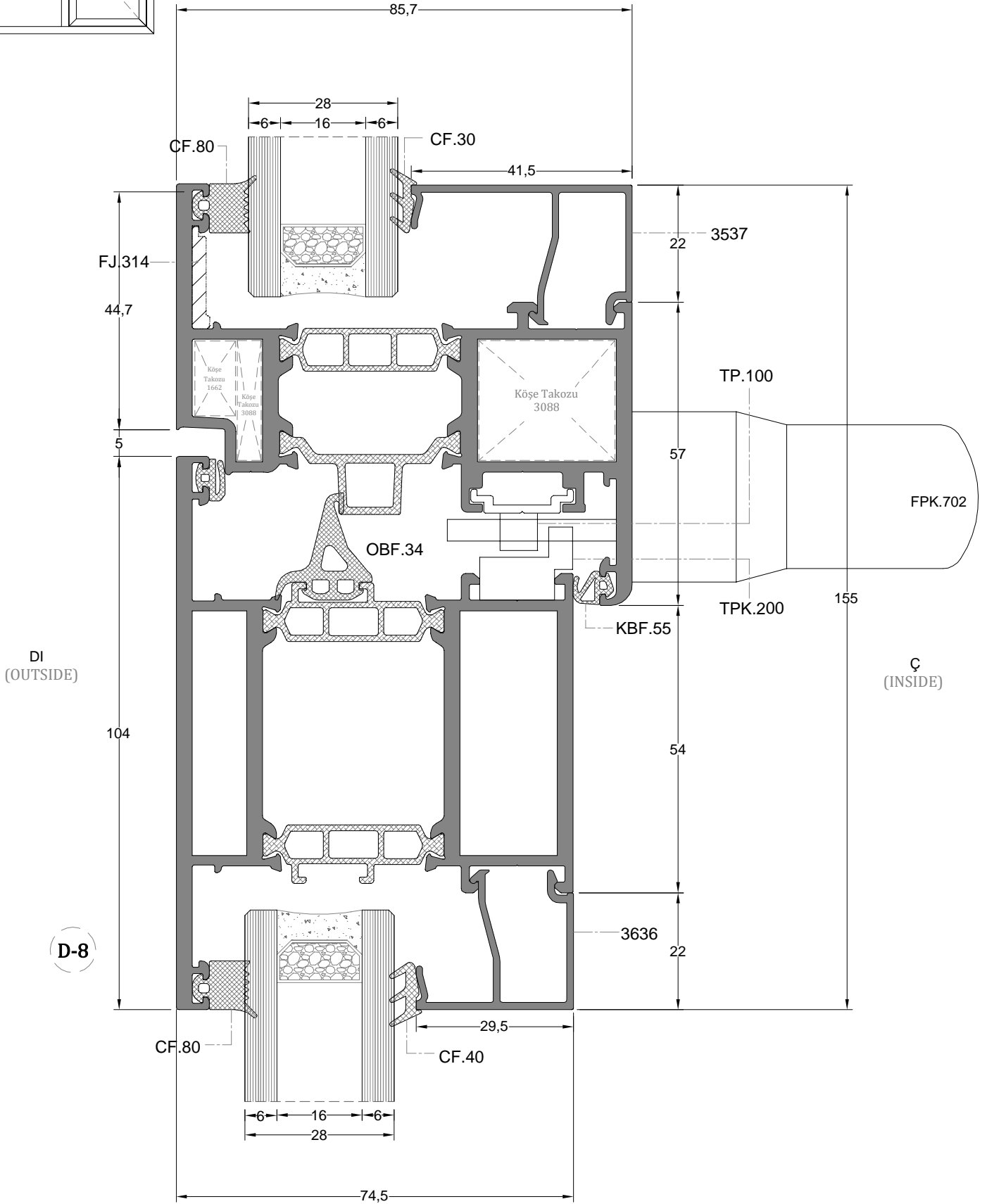
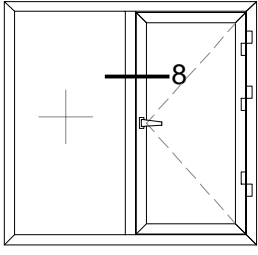

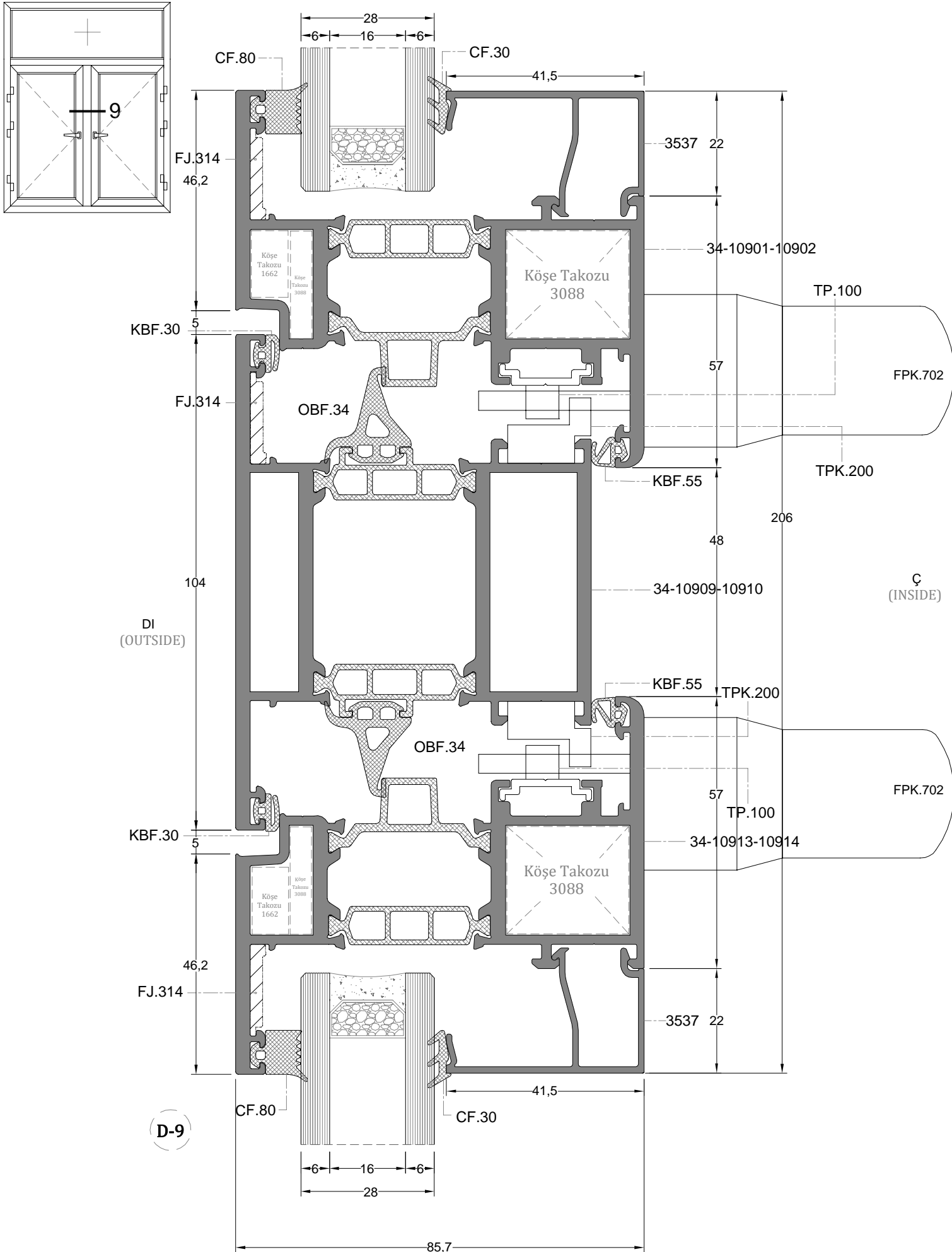



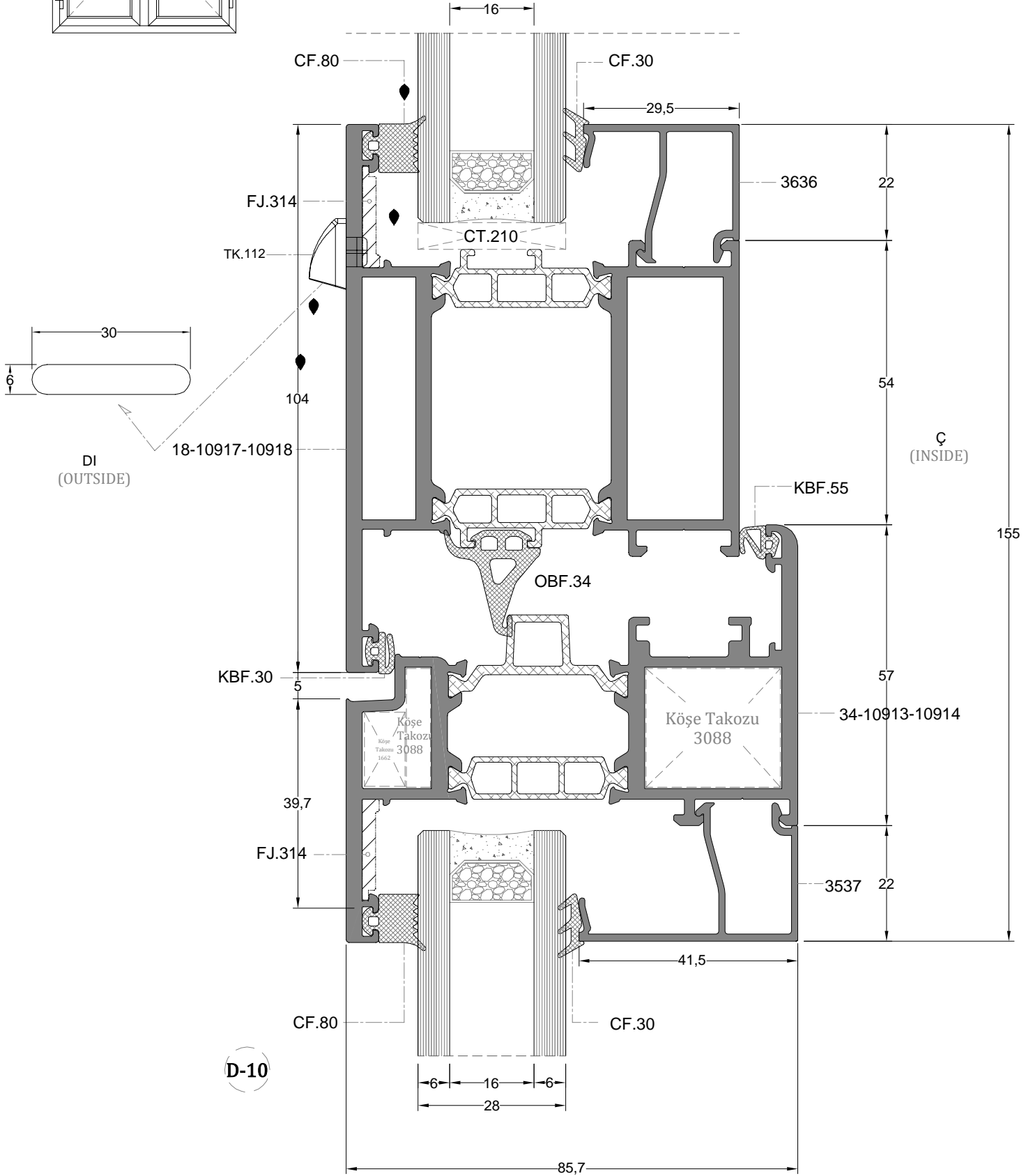
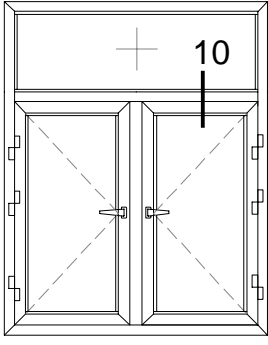

D-10

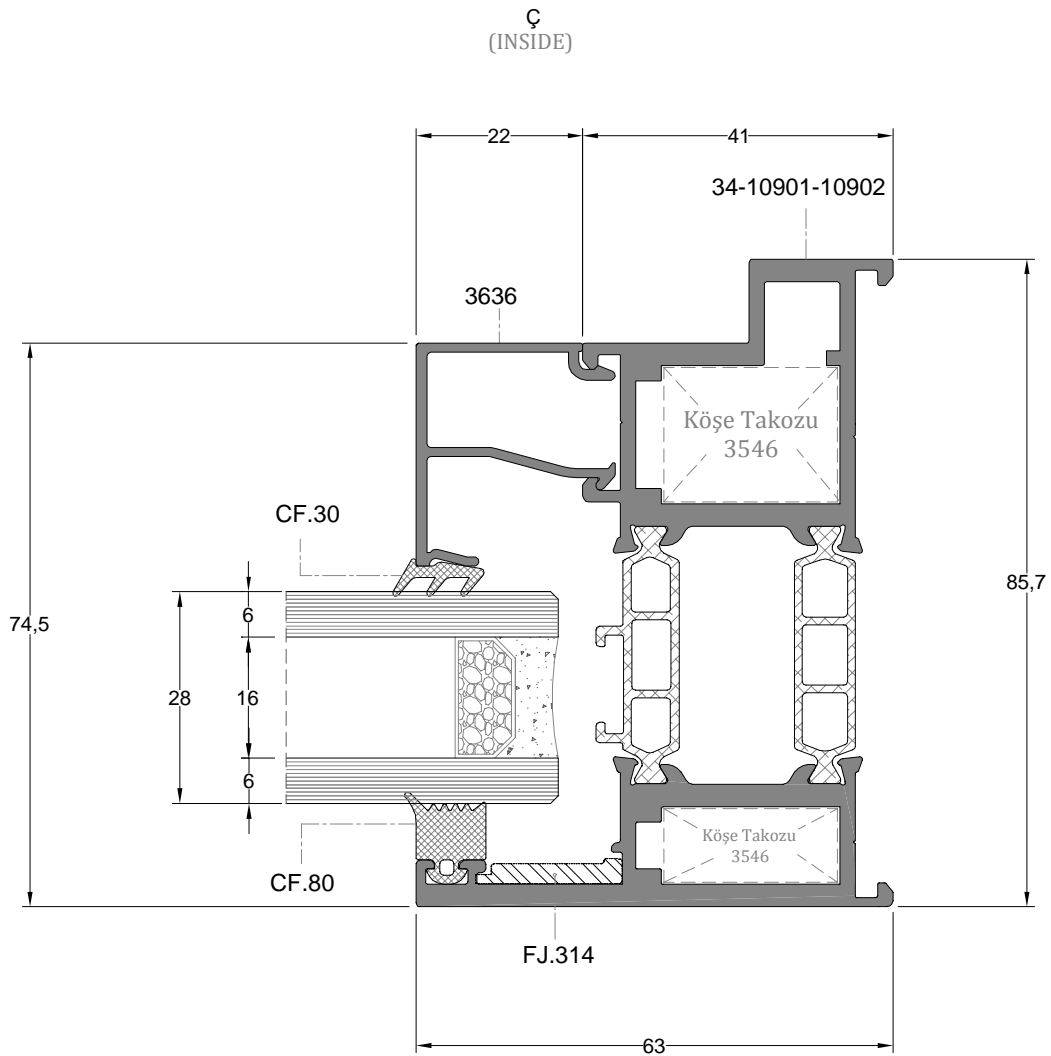
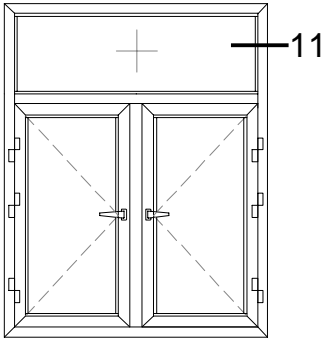

DI  
(OUTSIDE)

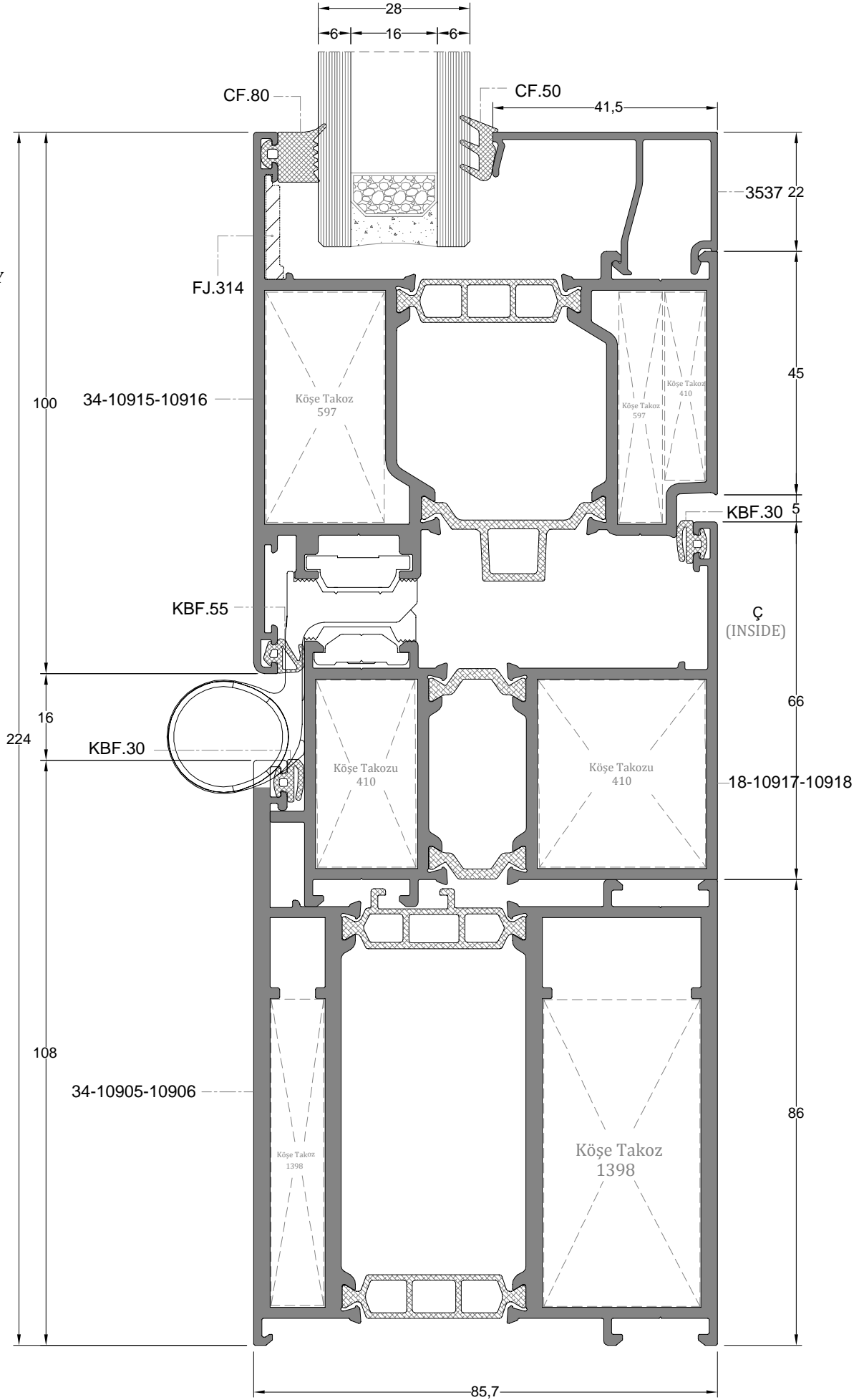
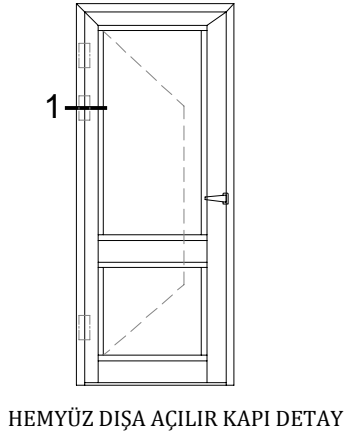

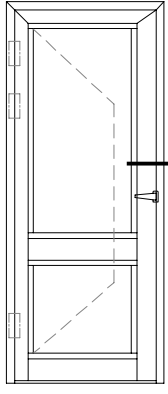

HEMYÜZ DIŞA AÇILIR KAPI DETAY

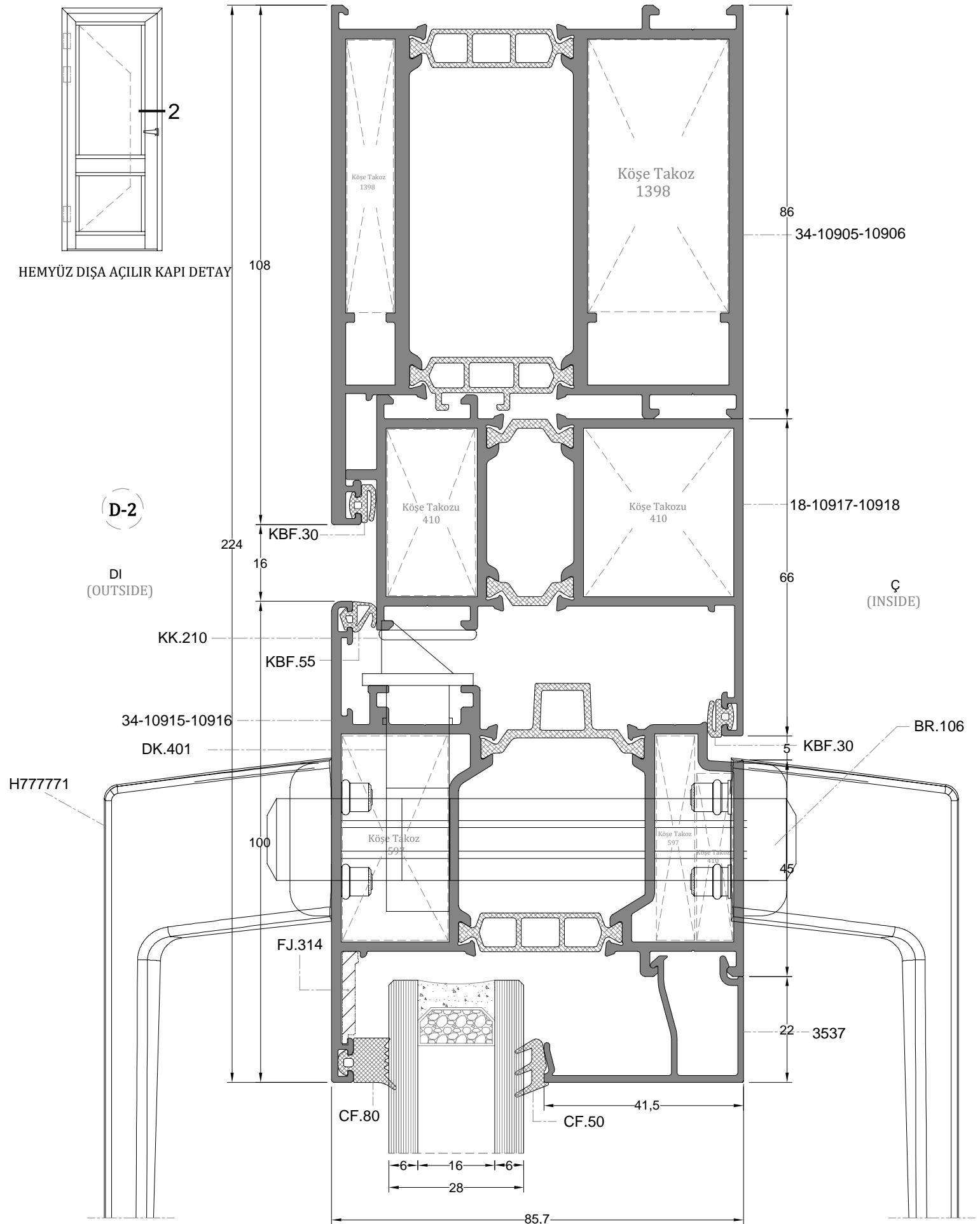

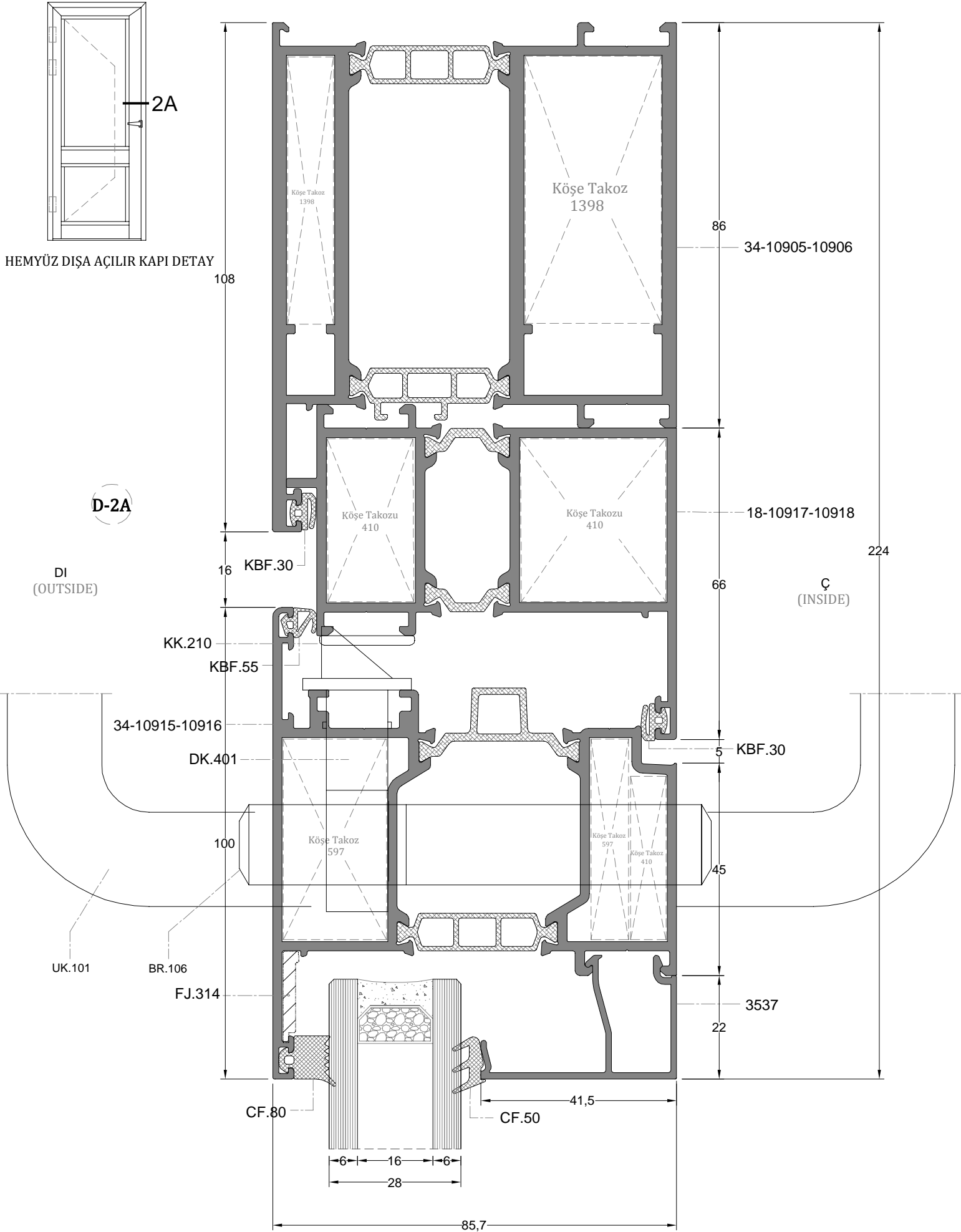

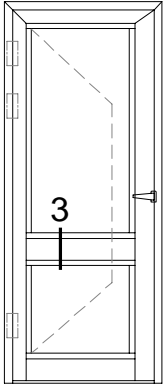

HEMYÜZ DIŞA AÇILIR KAPI DETAY

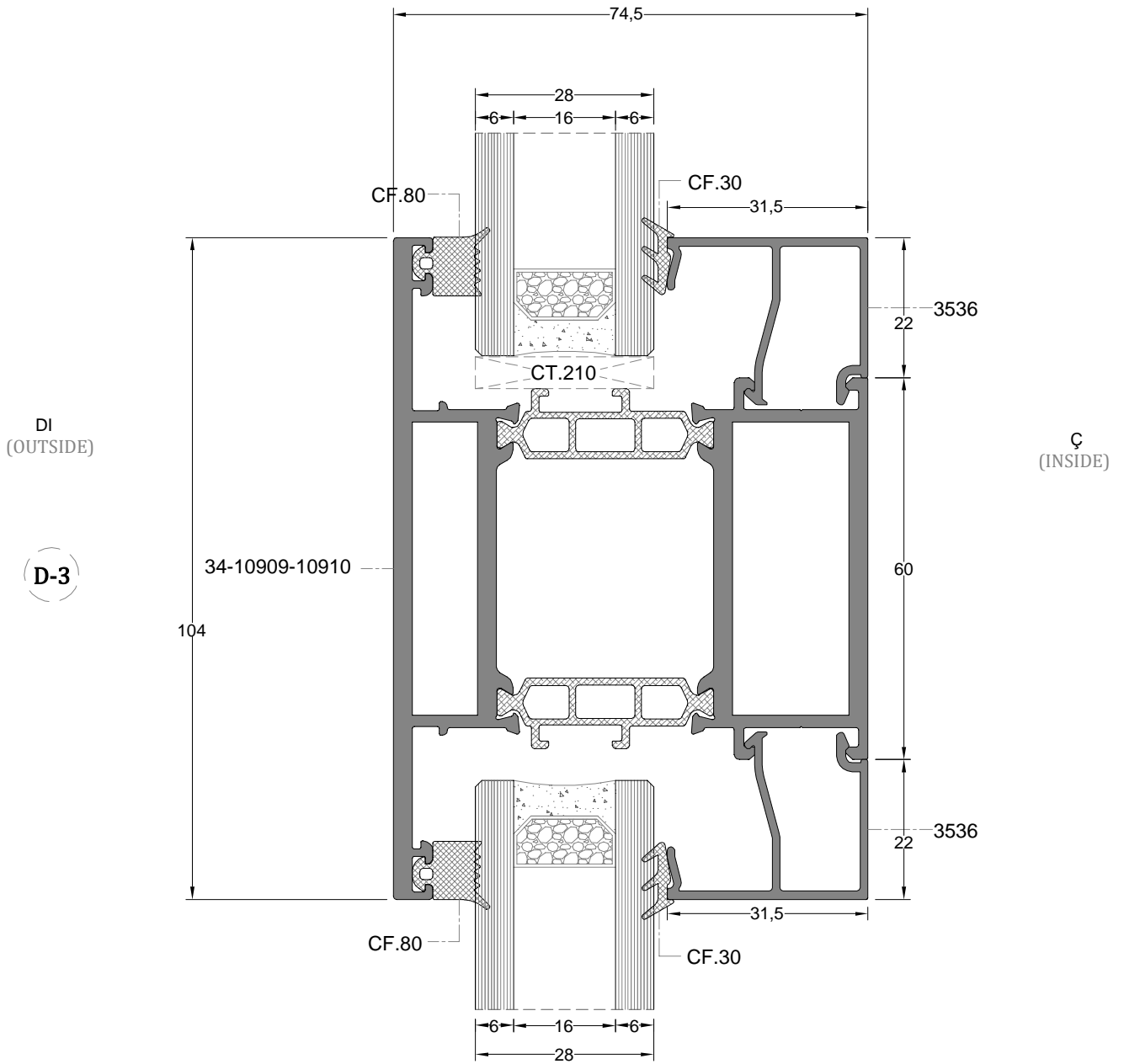

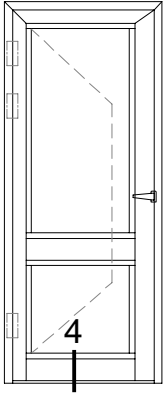

HEMYÜZ DIŞA AÇILIR KAPI DETAY

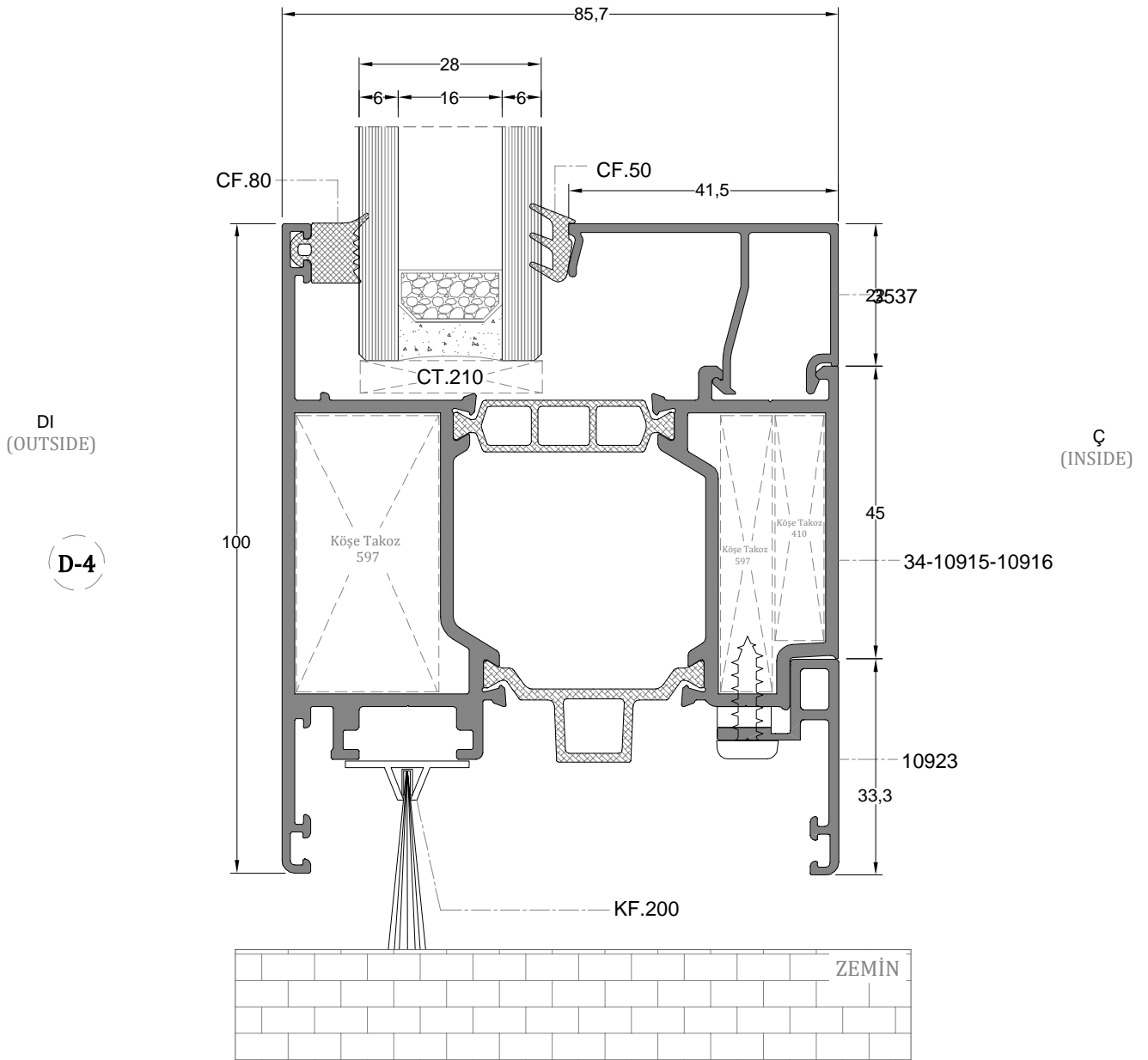

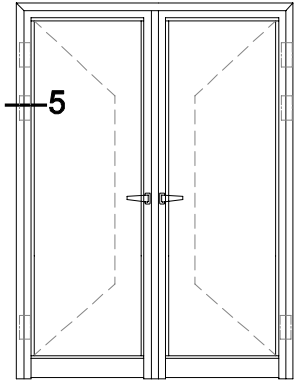

DI  
(OUTSIDE)

D-5

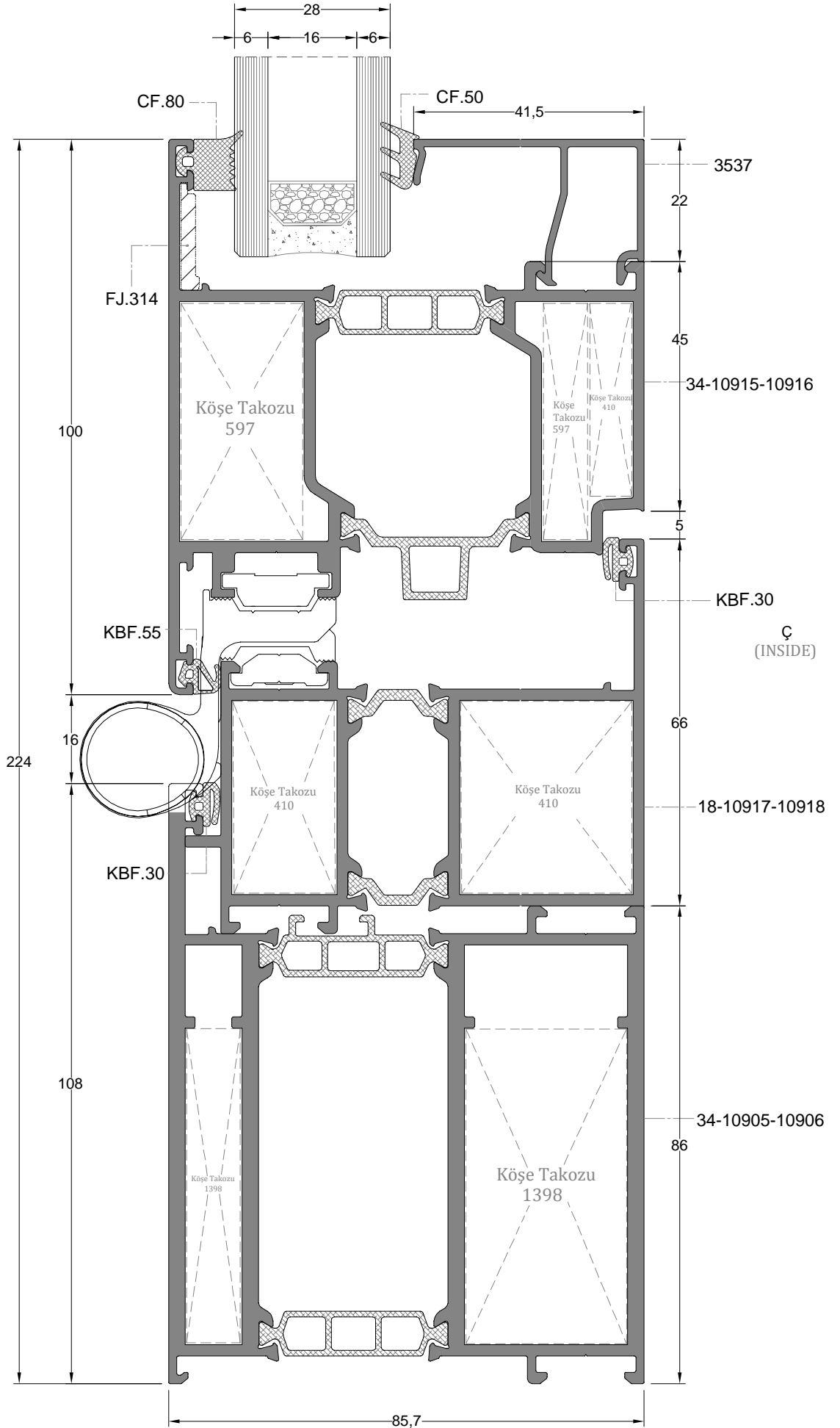



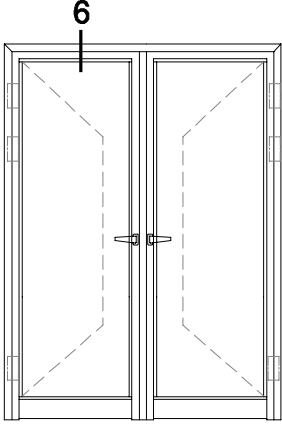

34-10905-10906

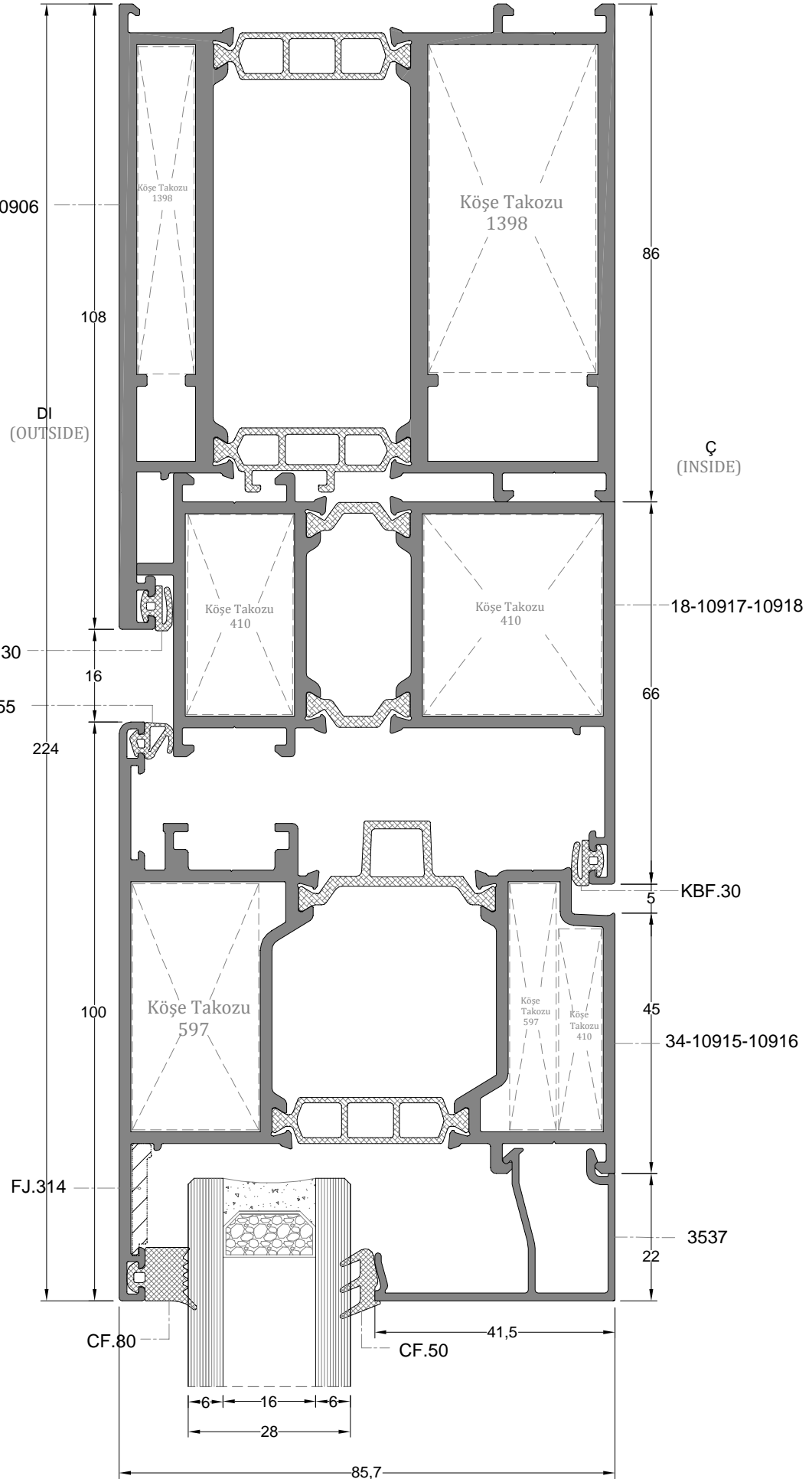

D-6

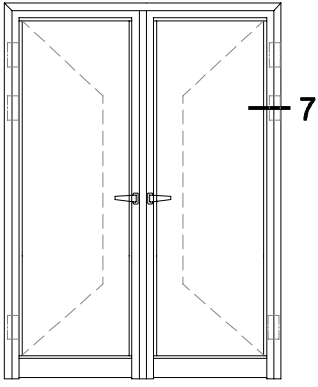

D-7

