

Giydirme Cephe Sistemi
Curtain Facade System

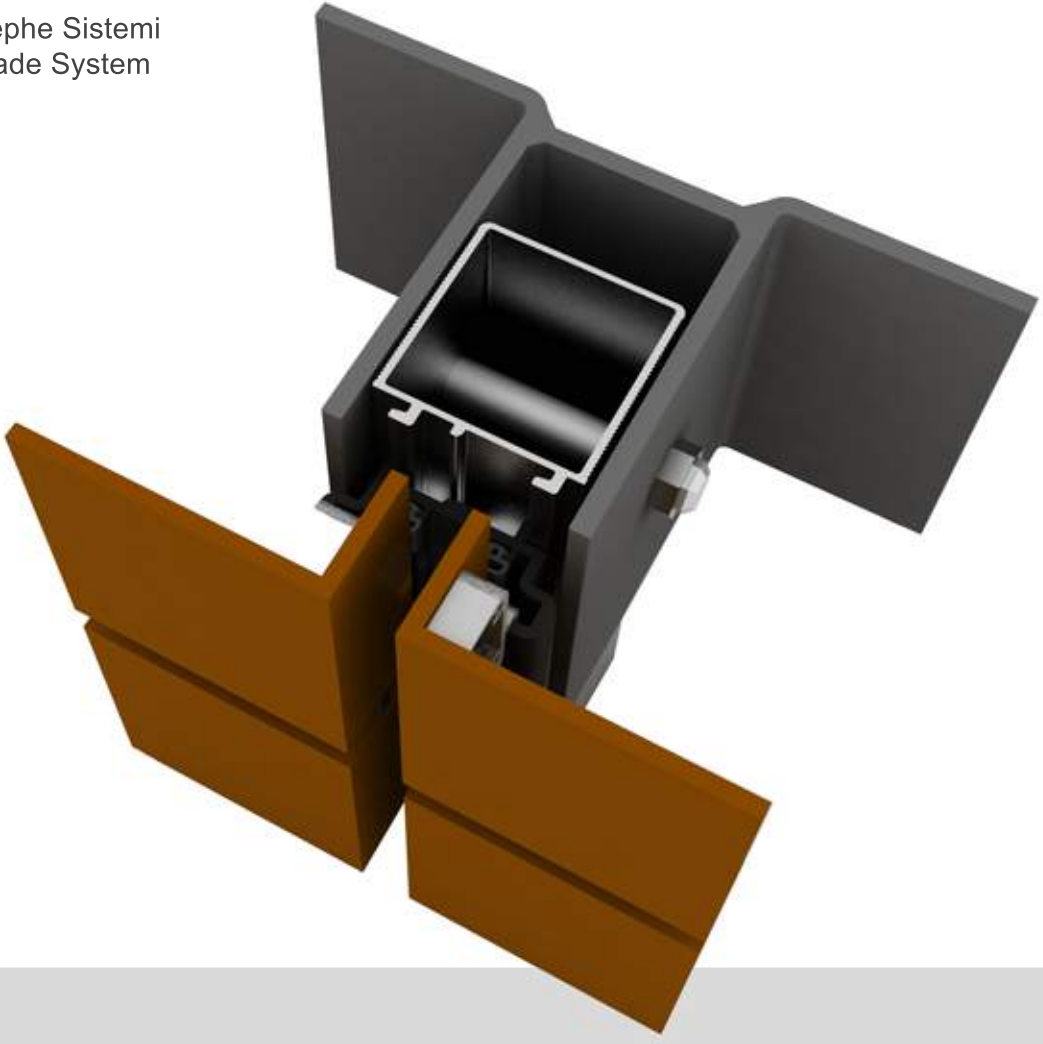

CP50

Kompozit Panel Sistemi
Composite Panel System

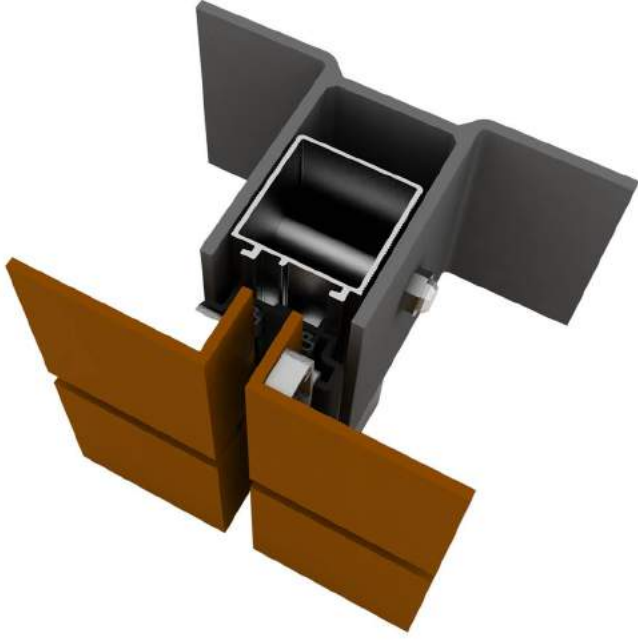

TEKNİK ÖZELLİKLER / TECHNICAL PROPERTIES

Anahtar Geçme Askılı



Klips Askılı



Çelik Konstrüksiyon





UYGULAMA SEÇENEKLERİ / APPLICATION OPTIONS

PrimeBond - A2 , FR











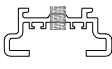

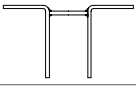
DuraBond - A2 , FR

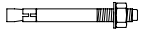
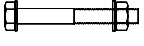

PROF L KES T PROFILE SECTION	PROF L KODU PROFILE CODE	PROF L ADI PROFILE NAME	Jx cm ⁴	Jy cm ⁴	A IRLIK (kg/m) WEIGHT
	6070	DÜ EY TA İYICI PROF L VERTICAL CARRIER PROFILE	14,88	13,96	0,988 kg/mt
	6937	DERZ ASKI PROF L JOINT HANGER PROFILE	-	-	0,576 kg/mt
	6938	DERZ KAPAK PROF L JOINT COVER PROFILE	-	-	0,249 kg/mt
	8711	KÖ E DÖNÜ PROF L CORNER PROFILE	-	-	0,302 kg/mt
	9790	T TA İYICI PROF L T CARRIER PROFILE	-	-	0,529 kg/mt
	5651	F PROF L F PROFILE	-	-	0,205 kg/mt
	5652	F PROF L F PROFILE	-	-	0,160 kg/mt
	477	F PROF L F PROFILE	-	-	0,220 kg/mt
	513	F PROF L F PROFILE	-	-	0,184 kg/mt
	8429	F PROF L F PROFILE	-	-	0,307 kg/mt
	9659	F PROF L F PROFILE	-	-	0,210 kg/mt
	6549	Z PROF L Z PROFILE	-	-	0,323 kg/mt
	507	H PROF L H PROFILE	-	-	0,251 kg/mt
	3117	H PROF L H PROFILE	-	-	0,225 kg/mt
	7476	H PROF L H PROFILE	-	-	0,257 kg/mt
	278	H PROF L H PROFILE	-	-	0,219 kg/mt
	6981	H PROF L H PROFILE	-	-	0,191 kg/mt
	4037	H PROF L H PROFILE	-	-	0,217 kg/mt
	8428	F PROF L F PROFILE	-	-	0,386 kg/mt

** Her profil için minimum sipari 300 kg'dır.
** Minimum order quantity is 300 kg per profile.

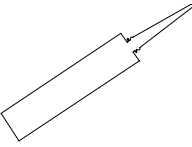
AKSESUAR ACCESSORY	STOK KODU REFERENCE CODE	AKSESUAR ADI DESCRIPTION	AKSESUAR KODU PRODUCT CODE	PAKET PACK
	03 012023	DERZ F T L (EPDM) LINE GASKET (EPDM)	CP50-DF.023	... mt / paket 10 kg
	75 130188	KL PS ASKI BA LANTI ELEMANI(50mm) S YAH ELOKSAL (M4) HANGER CONNECTION WITH CLIP	CP50-KLP.188	1 adet
	75 130194	PANEL KL PS BA LANTI ELEMANI (10 mm) PRESS PANEL CONNECTION WITH CLIP	CP50-KLP.194	1 adet
	75 130208	ANAHTAR GEÇME BA LANTI ELEMANI (50 mm) S YAH ELOKSAL (M4) KEY INSERT CONNECTION	CP50-AGP.208	1 adet
	01 100116	100/160 U ANKRAJ 100/160 U ANCHORAGE	CP50-AJ.116	1 pk / 1 ad
	01 100111	100/60 L ANKRAJ 100/60 L ANCHORAGE	CP50-AJ.111	1 pk / 1 ad
	01 100208	M10x110 ÇEL K DÜBEL M10x110 STEEL DOWEL	CP50-ÇD.208	1 pk / 300 ad
	01 100200	M10x90 CIVATA GRUBU M10x90 BOLT GROUP	CP50-ÇD.200	1 pk / 100 ad
	03 060103	10 MM DERZ DOLGU F T L 10 MM LINE GASKET	CP50-DDF.103	1 pk / 900 mt
	03 060104	15 MM DERZ DOLGU F T L 15 MM LINE GASKET	CP50-DDF.104	1 pk / 450 mt
	03 060105	20 MM DERZ DOLGU F T L 20 MM LINE GASKET	CP50-DDF.105	1 pk / 270 mt
	11 010297	Ø2,9x13 YILDIZ HAV A BA LI SAÇ V DA SCREW	CP50-SC.297	1 pk / 1000 ad
	11 011015	Ø3,9x16 YILDIZ HAV A BA LI SAÇ V DA SCREW	CP50-SC.015	1 pk / 1000 ad
	11 011016	Ø3,9x19 YILDIZ HAV A BA LI SAÇ V DA SCREW	CP50-SC.016	1 pk / 1000 ad
	11 010293	Ø3,9x22 YILDIZ HAV A BA LI MATKAP UÇLU V DA SCREW	CP50-SC.293	1 pk / 1000 ad
	08 040230	S L KON (S YAH) SILICON (BLACK)	CP50-SLK.230	1 koli / 24 ad

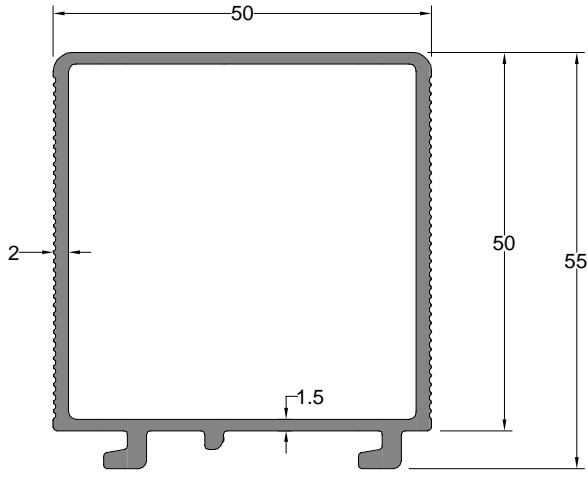

Dü ey Ta ıyıcı Profili	Profil Kodu	(kg/mt)	Jx cm ⁴	Jy cm ⁴
VERTICAL CARRIER PROFILE	Profile Code	Weight		
	6070	0,988	14,88	13,96

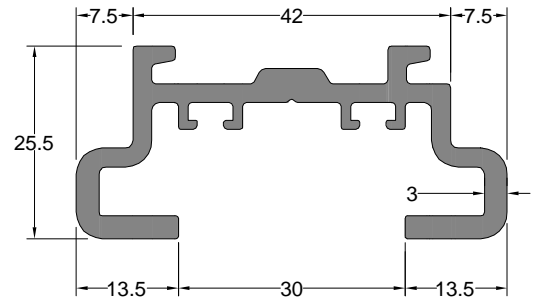

Klips Askı Profili	Profil Kodu	(kg/mt)	Jx cm ⁴	Jy cm ⁴
HANGER CONNECTION WITH CLIP PROFILE	Profile Code	Weight		
	6071	1,005	12,81	2,22

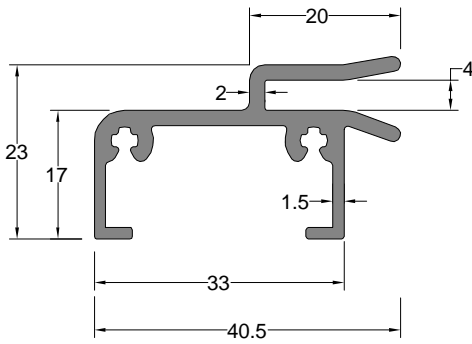

Panel Klips Profili	Profil Kodu	(kg/mt)
PANEL CONNECTION WITH CLIP PROFILE	Profile Code	Weight
	6072	0,584

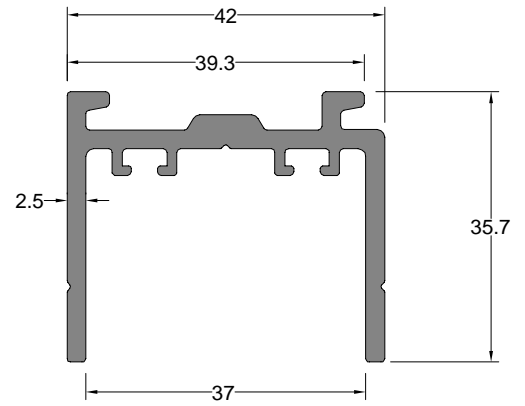

Klips Askı Ba lantı Profili	Profil Kodu	(kg/mt)	Jx cm ⁴	Jy cm ⁴
HANGER CONNECTION WITH PROFILE	Profile Code	Weight		
	6073	0,883	8,45	3,08

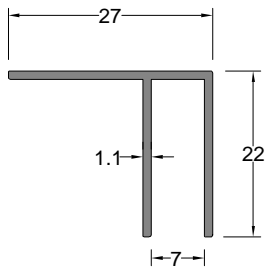

F Profili	Profil Kodu	(kg/mt)
F PROFILE	Profile Code	Weight
	5651	0,205

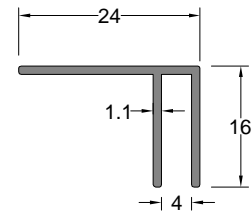

F Profili	Profil Kodu	(kg/mt)
F PROFILE	Profile Code	Weight
	5652	0,160

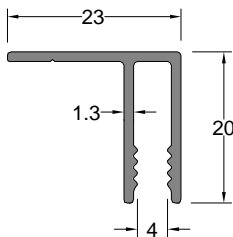

F Profili	Profil Kodu	(kg/mt)
F PROFILE	Profile Code	Weight
	477	0,220

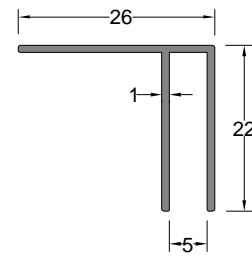

F Profili	Profil Kodu	(kg/mt)
F PROFILE	Profile Code	Weight
	513	0,184

** Her profil için minimum sipari 300 kg'dır.
** Minimum order quantity is 300 kg per profile.

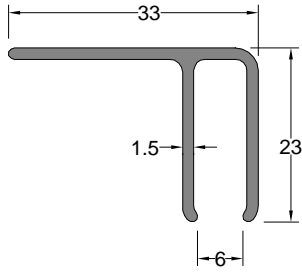

F Profili	Profil Kodu	(kg/mt)
F PROFILE	Profile Code	Weight
	8429	0,307

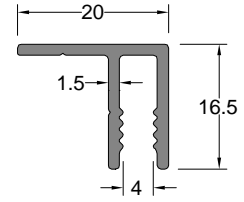

F Profili	Profil Kodu	(kg/mt)
F PROFILE	Profile Code	Weight
	9659	0,210

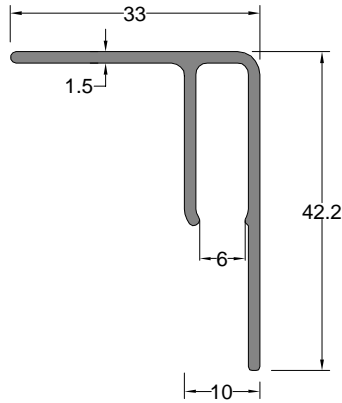

F Profili	Profil Kodu	(kg/mt)
F PROFILE	Profile Code	Weight
	8428	0,386

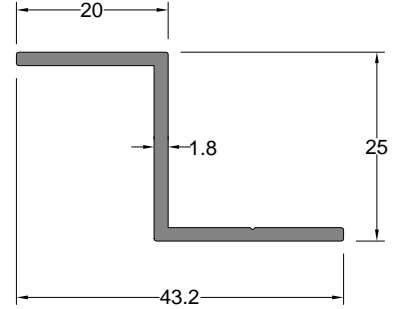

Z Profili	Profil Kodu	(kg/mt)
Z PROFILE	Profile Code	Weight
	6549	0,323

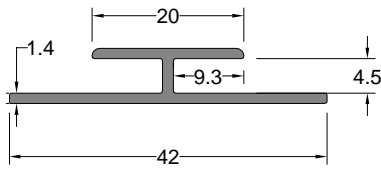

H Profili	Profil Kodu	(kg/mt)
H PROFILE	Profile Code	Weight
	507	0,251

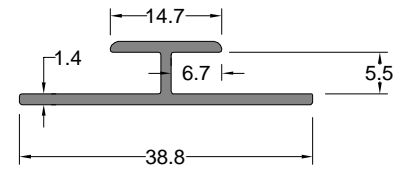

H Profili	Profil Kodu	(kg/mt)
H PROFILE	Profile Code	Weight
	3117	0,225

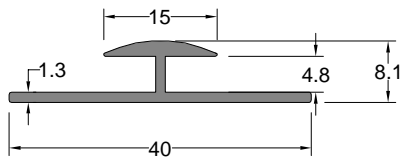

H Profili	Profil Kodu	(kg/mt)
H PROFILE	Profile Code	Weight
	4037	0,217

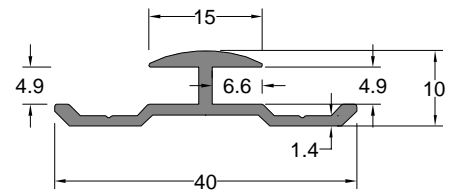

H Profili	Profil Kodu	(kg/mt)
H PROFILE	Profile Code	Weight
	7476	0,257

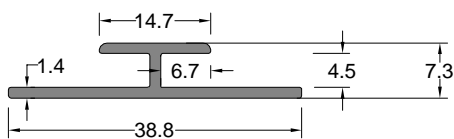

H Profili	Profil Kodu	(kg/mt)
H PROFILE	Profile Code	Weight
	278	0,219

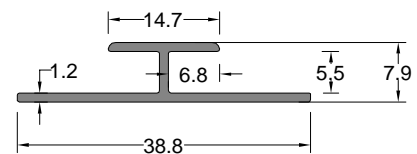

H Profili	Profil Kodu	(kg/mt)
H PROFILE	Profile Code	Weight
	6981	0,191

** Her profil için minimum sipari 300 kg'dır.
** Minimum order quantity is 300 kg per profile.

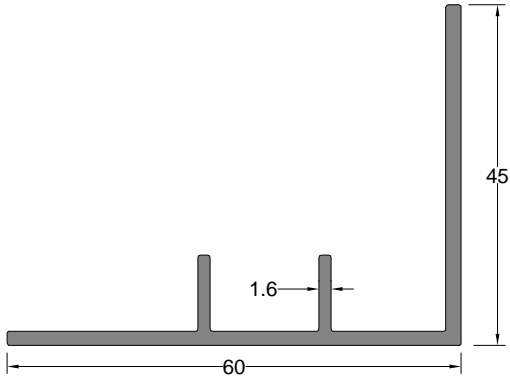

L Profili	Profil Kodu	(kg/mt)
L PROFILE	Profile Code	Weight
	8427	0,629

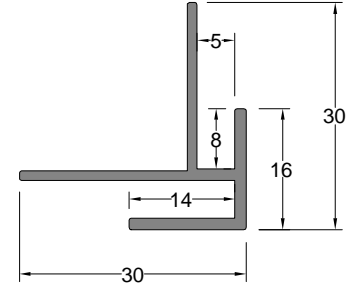

Kö e Dönü Profili	Profil Kodu	(kg/mt)
CORNER PROFILE	Profile Code	Weight
	8711	0,302

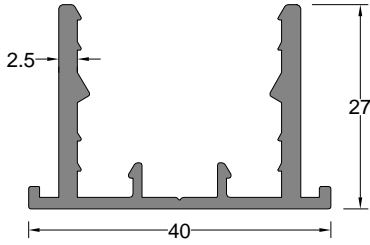

Derz Askı Profili	Profil Kodu	(kg/mt)
JOINT HANGER PROFILE	Profile Code	Weight
	6937	0,576

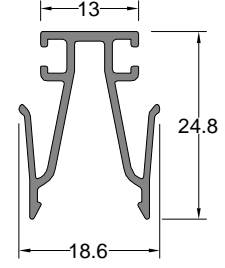

Derz Kapak Profili	Profil Kodu	(kg/mt)
JOINT COVER PROFILE	Profile Code	Weight
	6938	0,249

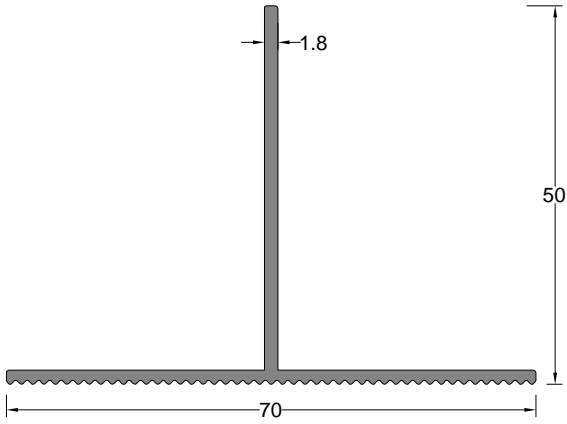

T Ta iyıcı Profili	Profil Kodu	(kg/mt)
T CARRIER PROFILE	Profile Code	Weight
	9790	0,529

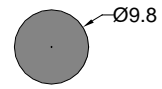

Mil Profili	Profil Kodu	(kg/mt)
SHAFT PROFILE	Profile Code	Weight
	4320	0,204

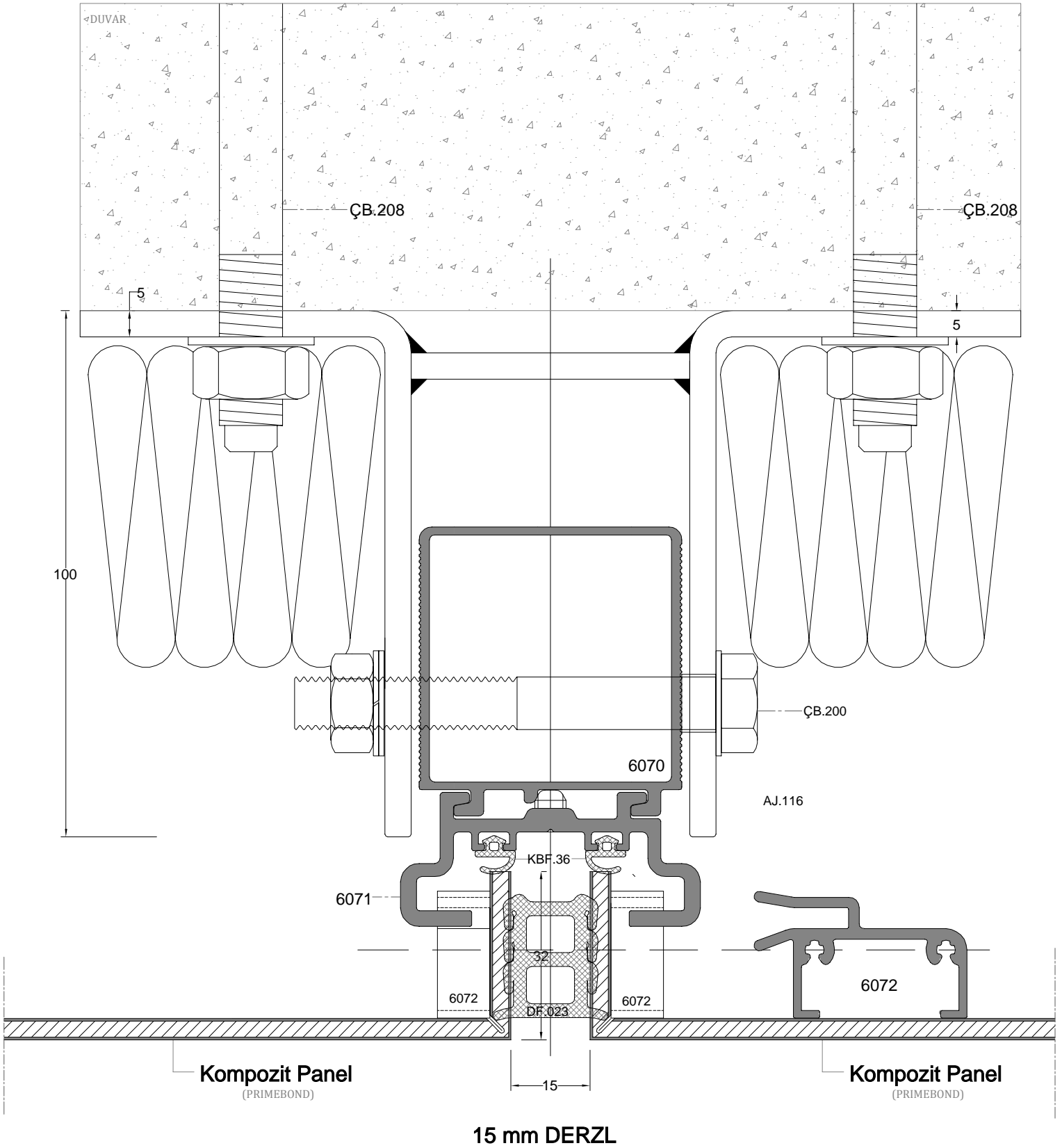

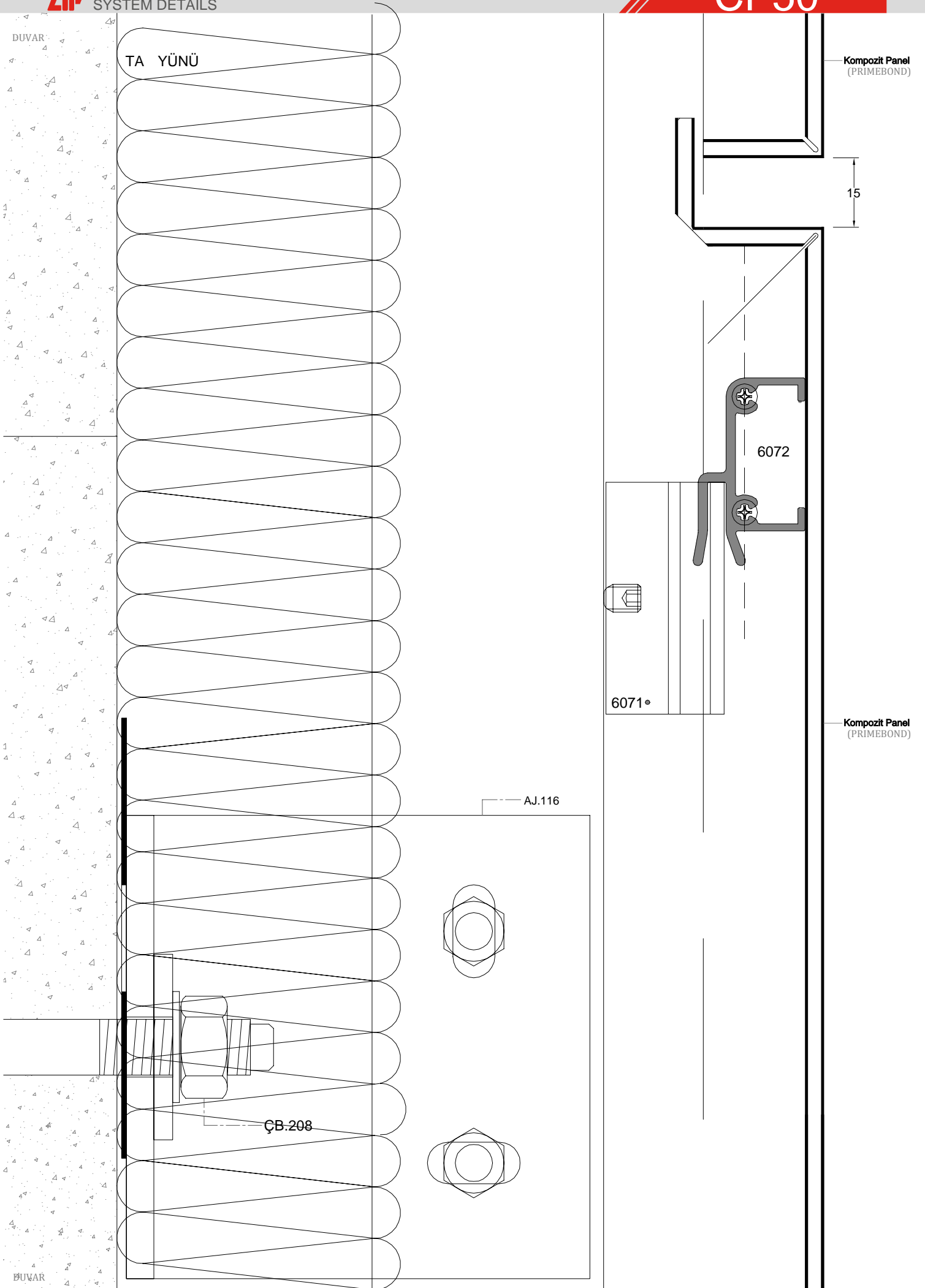

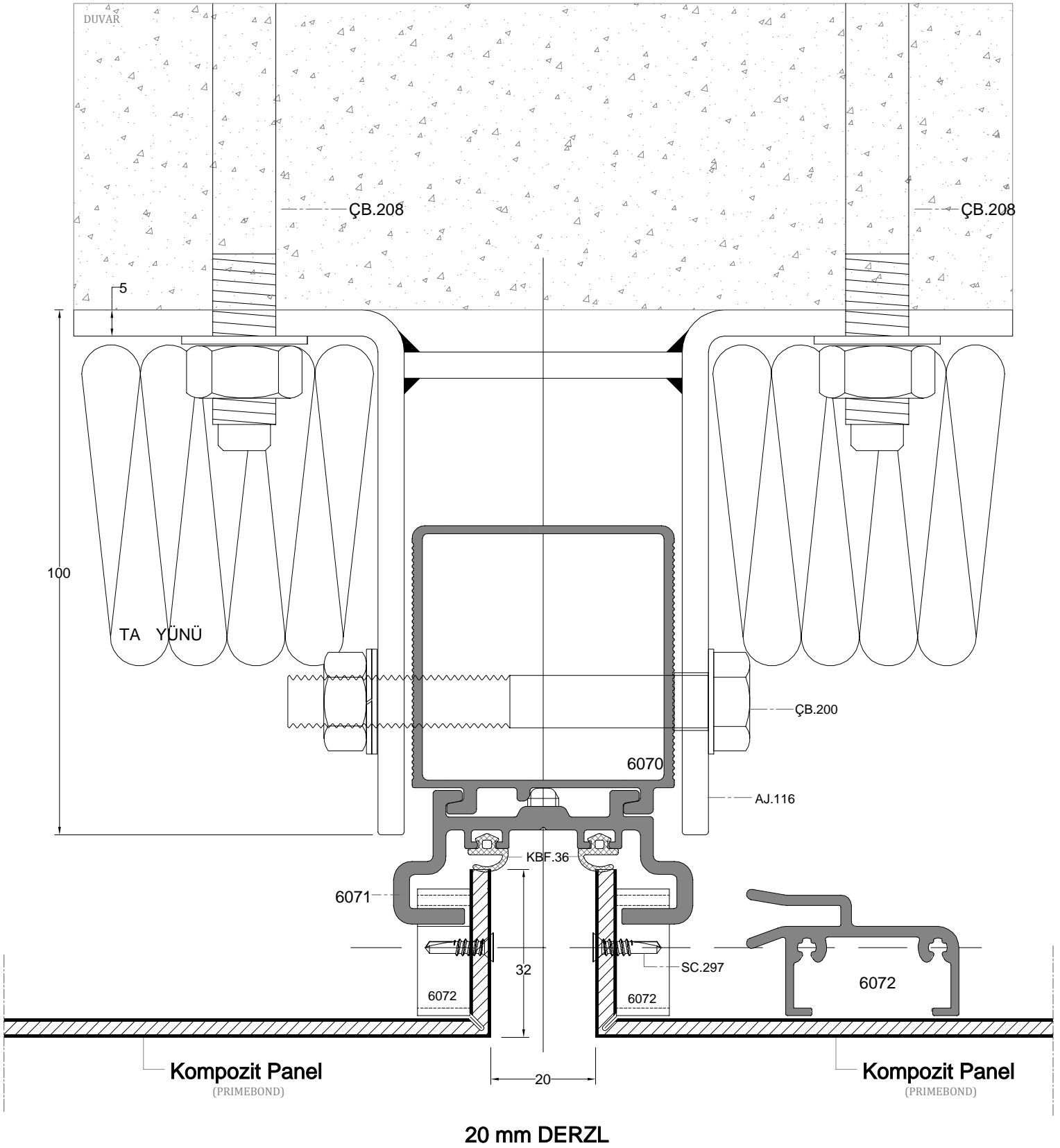

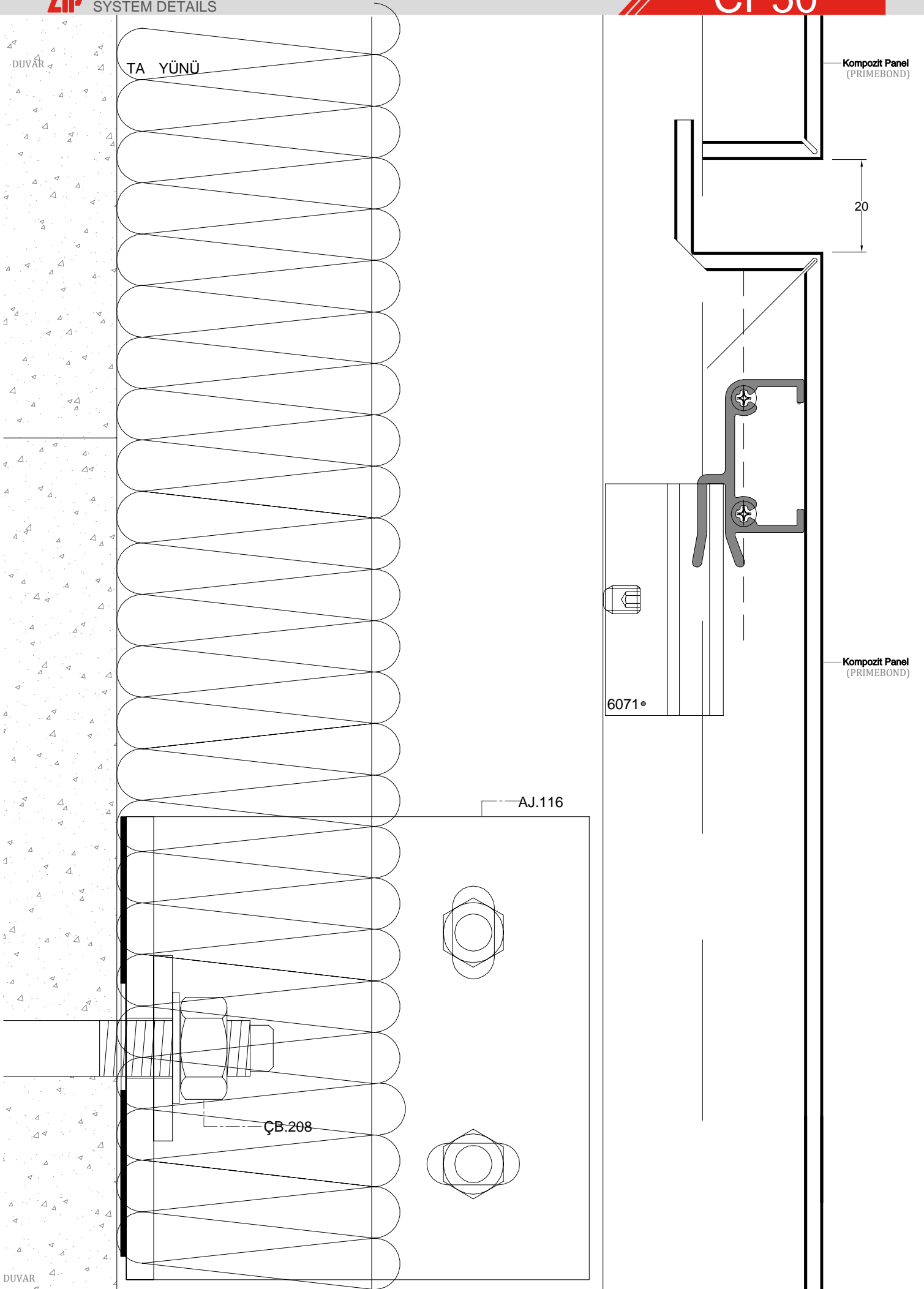

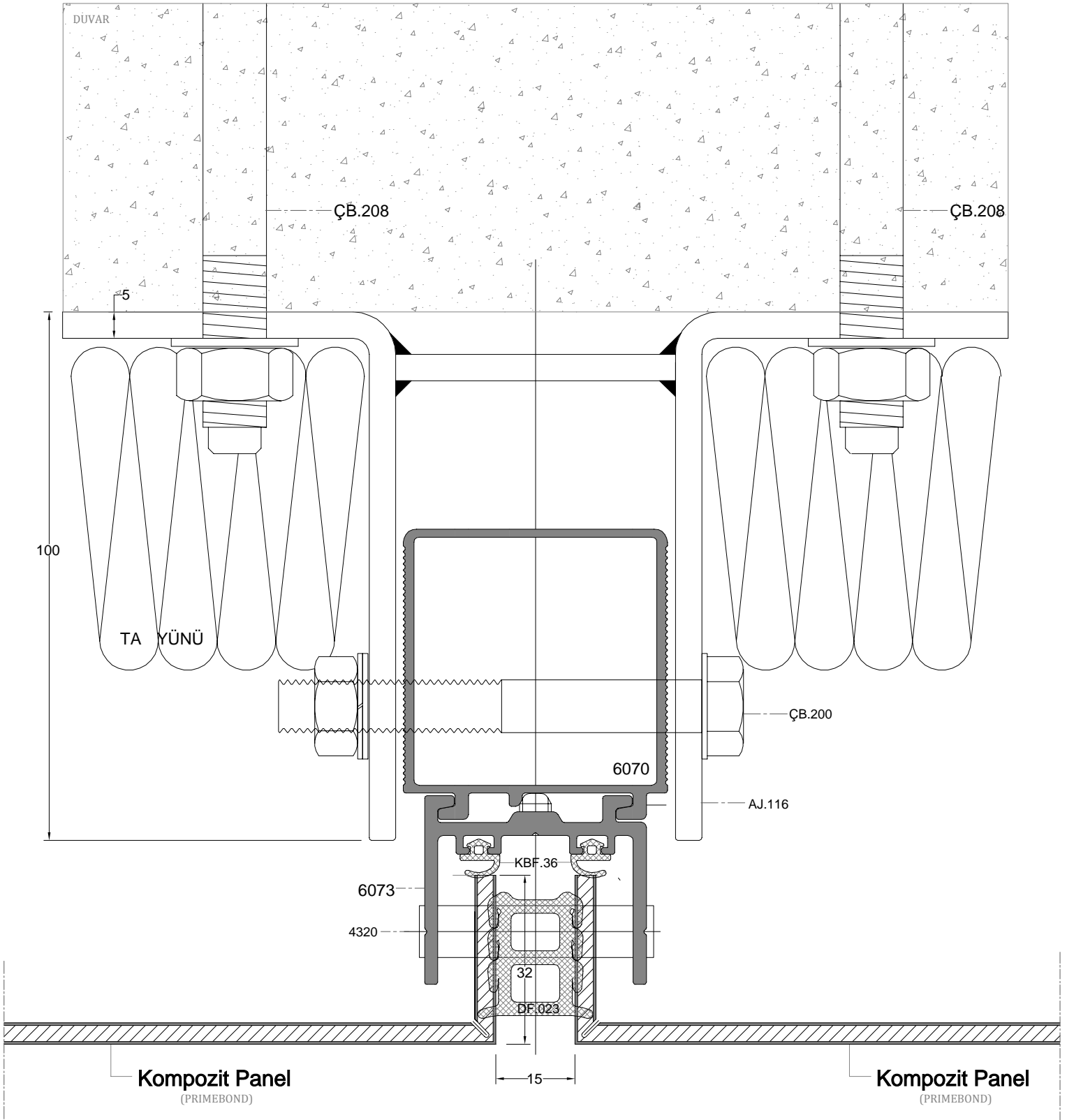

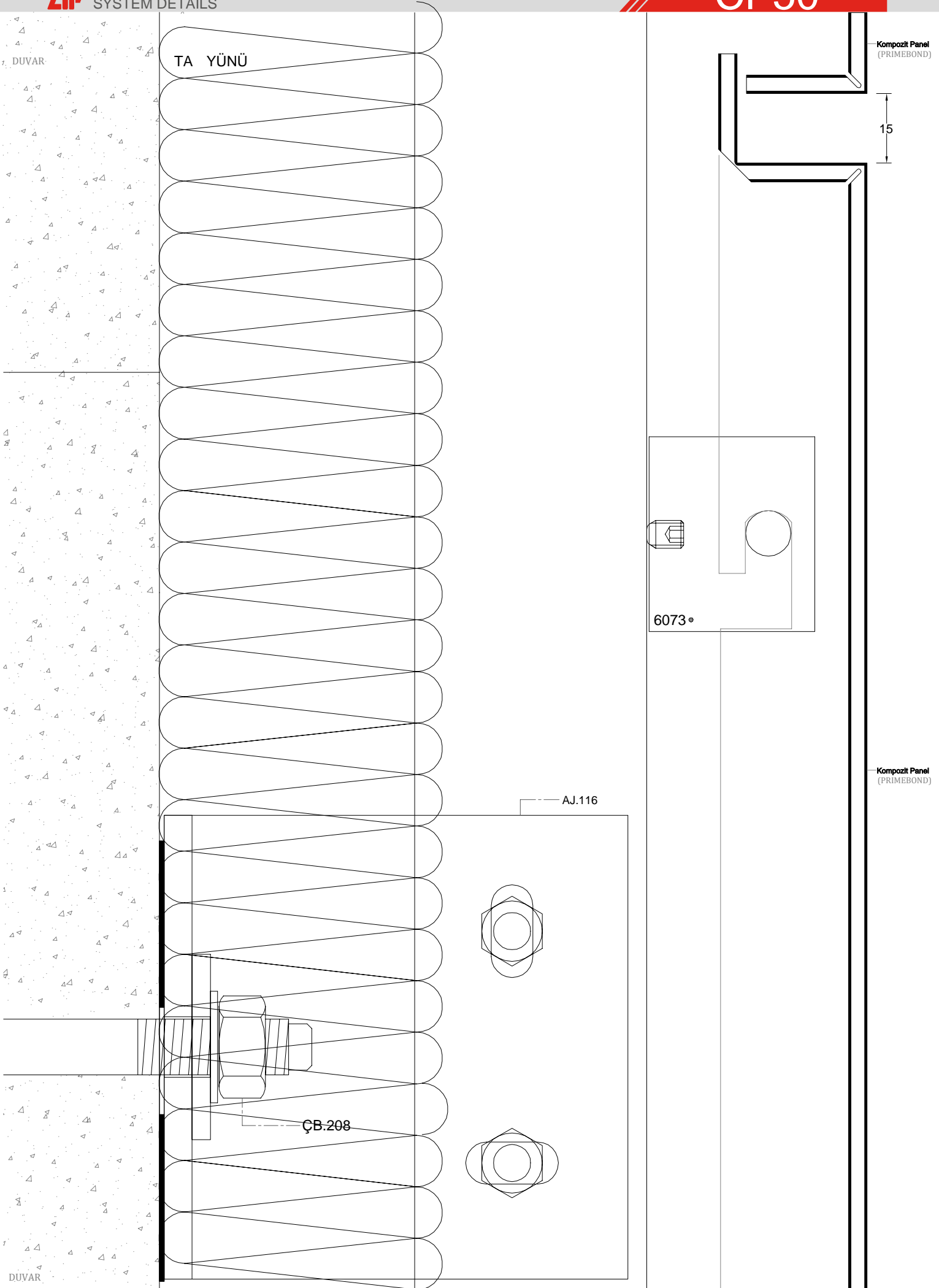

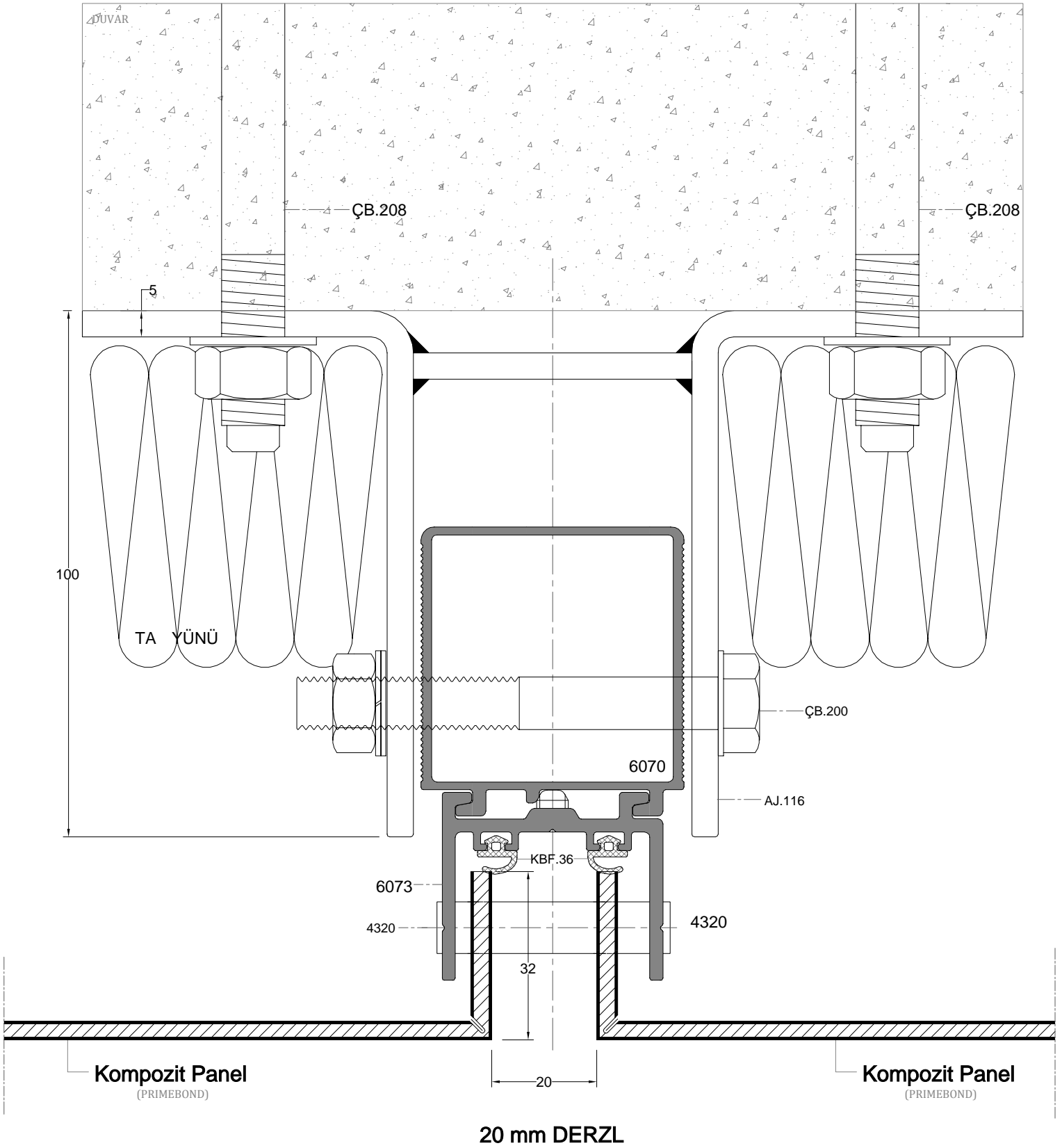

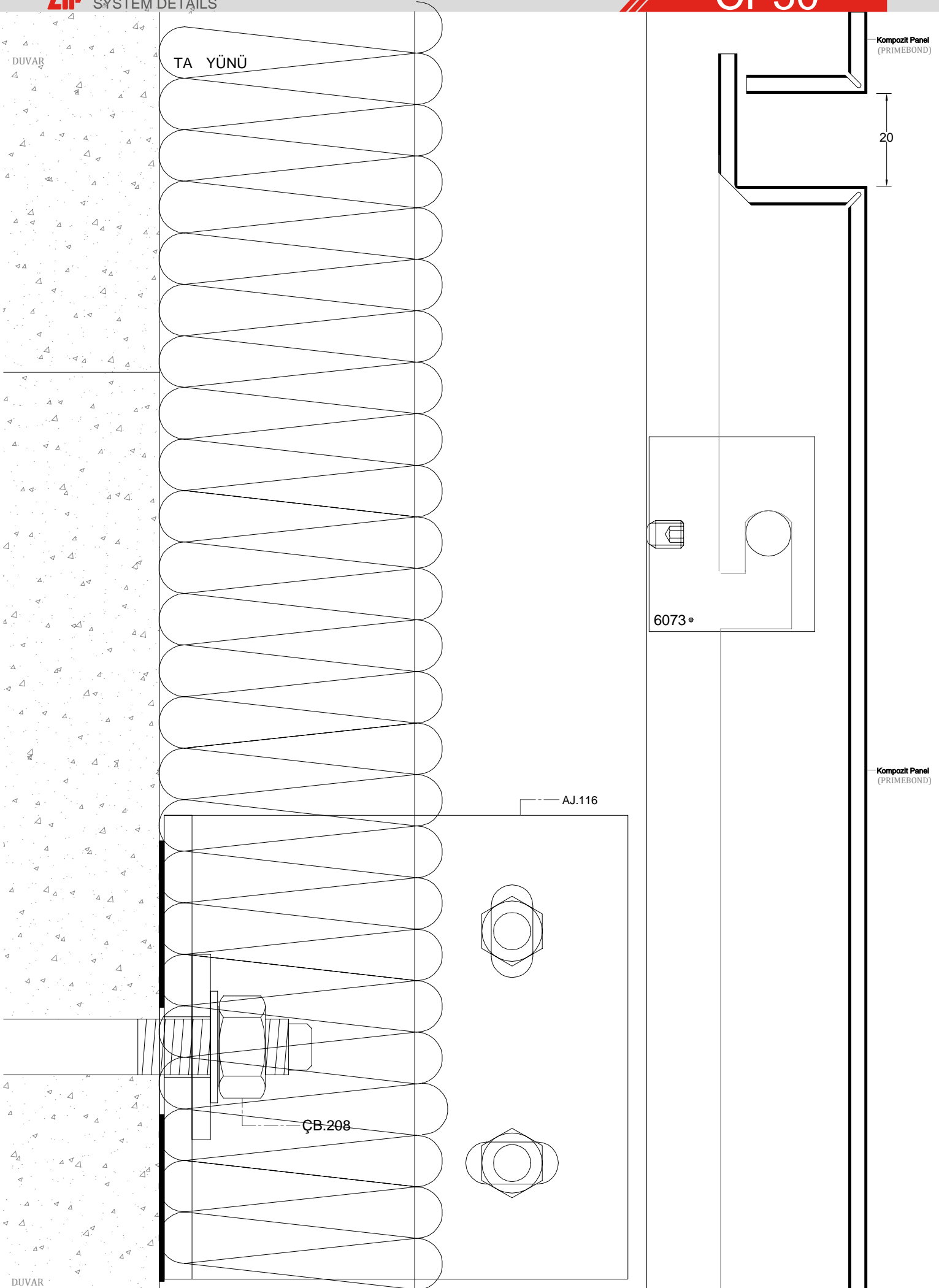

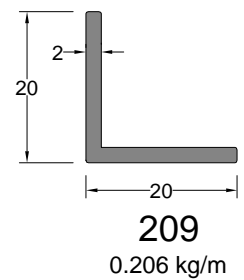
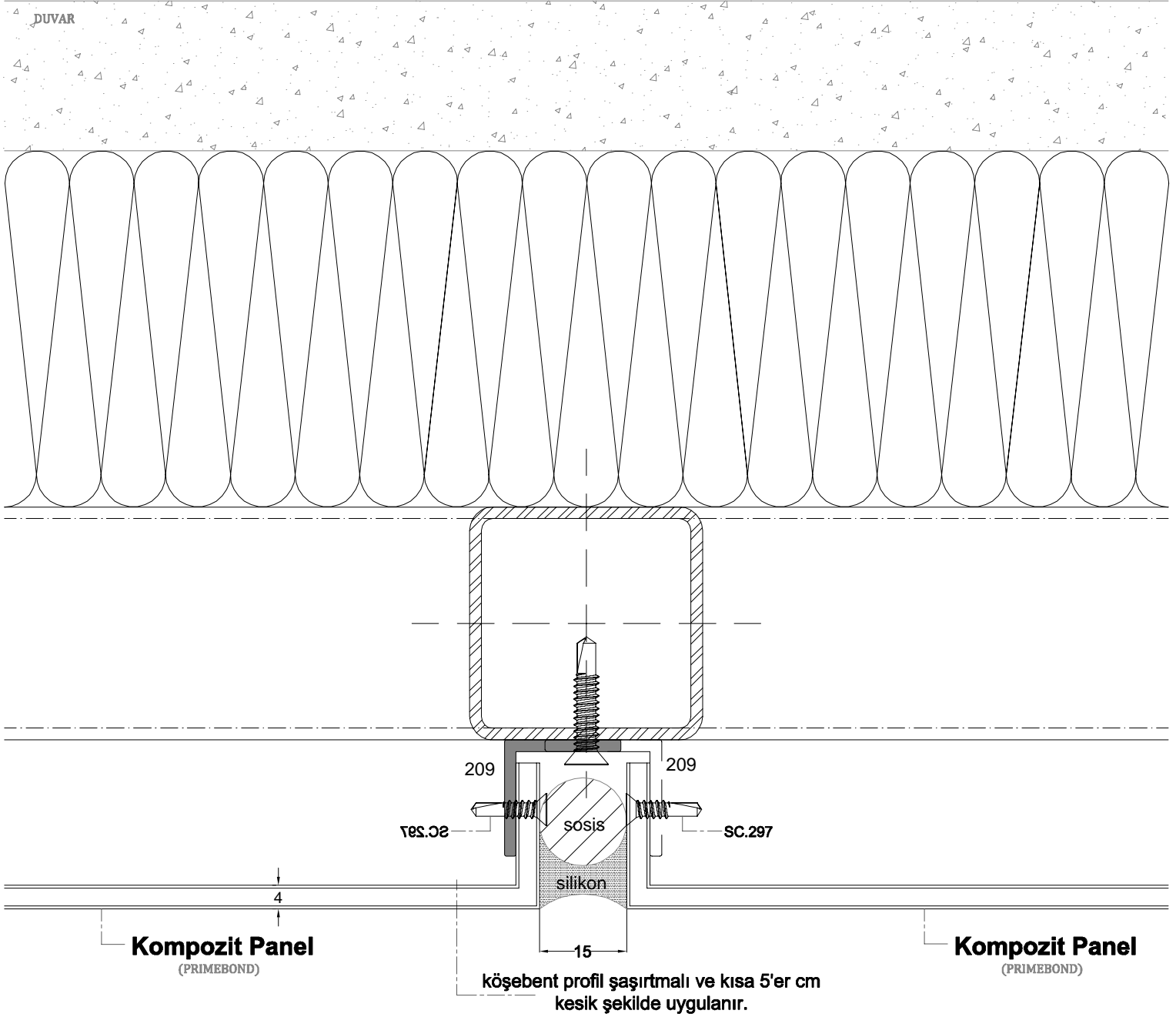

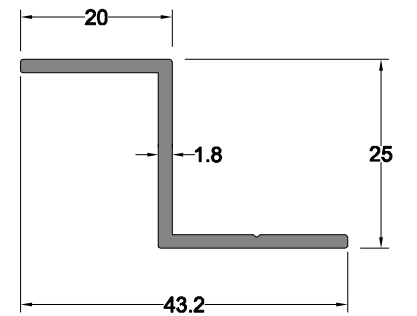
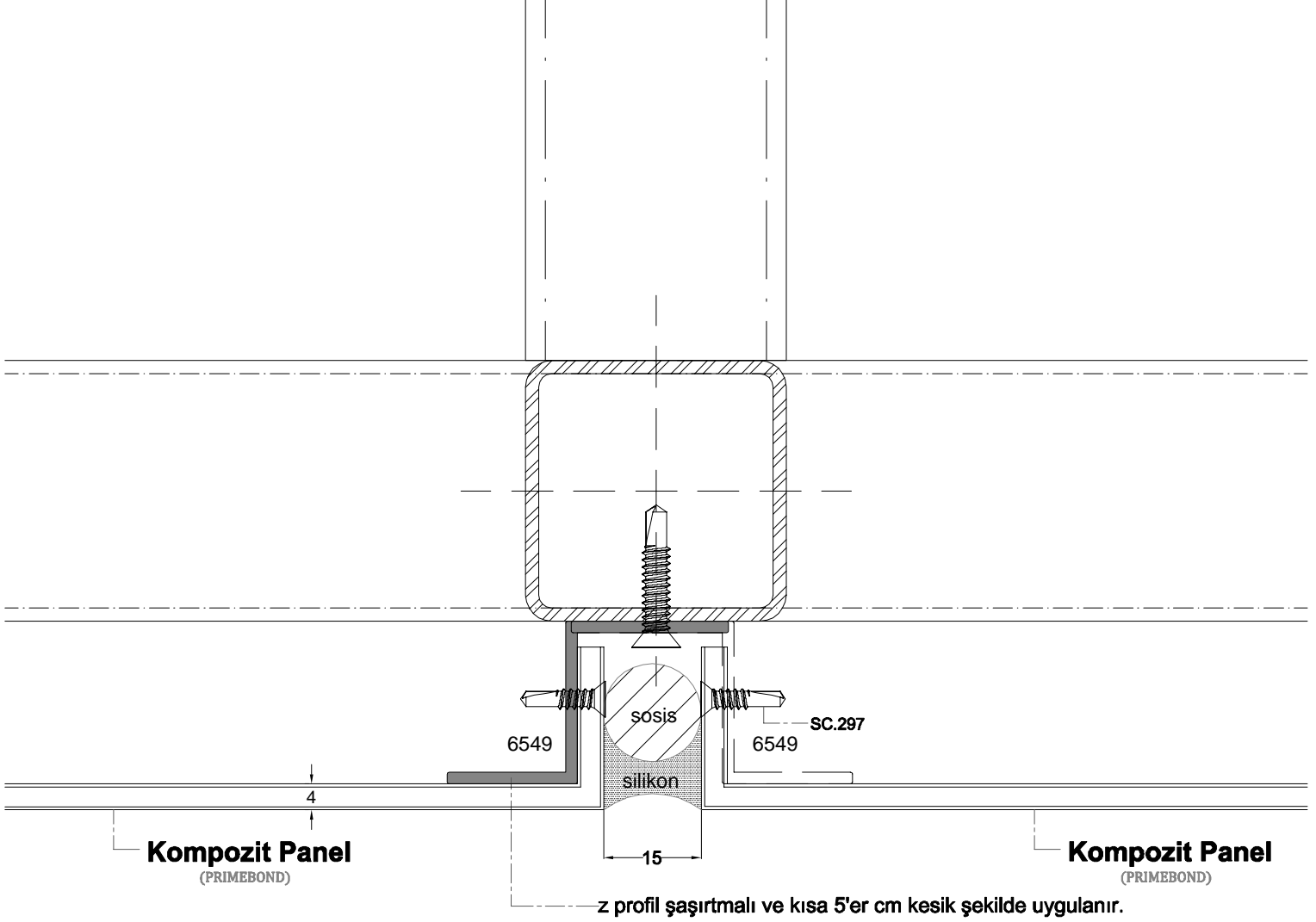

6549
0.323 kg/m

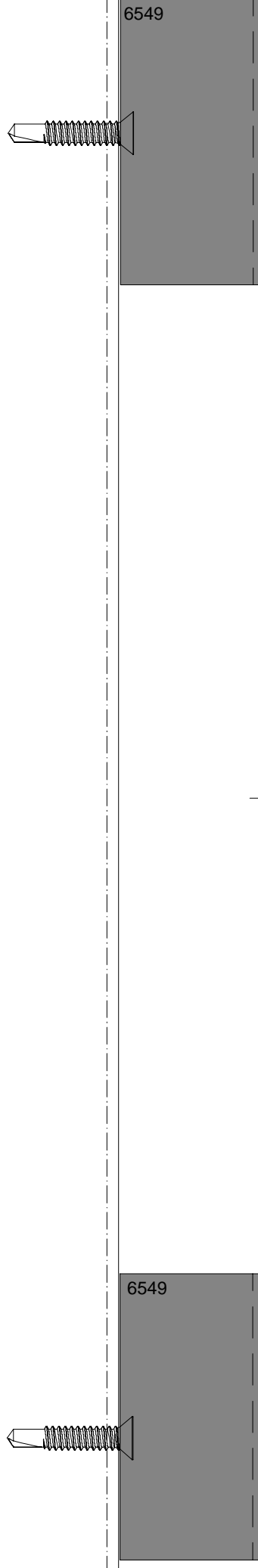
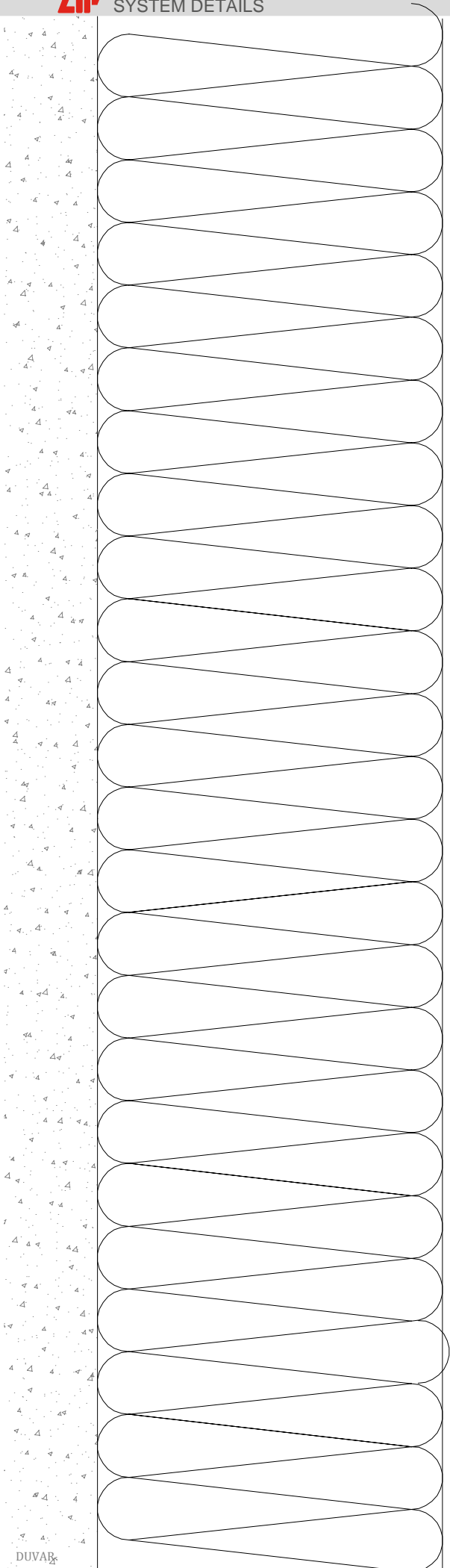

Kompozit Panel
(PRIMEBOND)

4

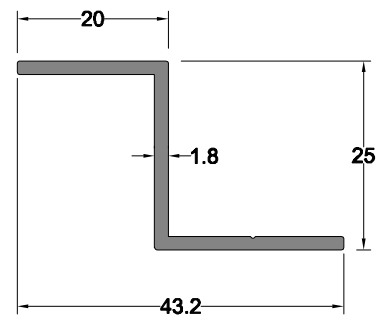

6549
0.323 kg/m

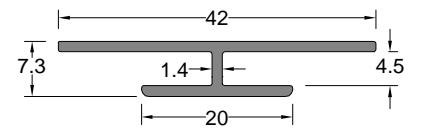
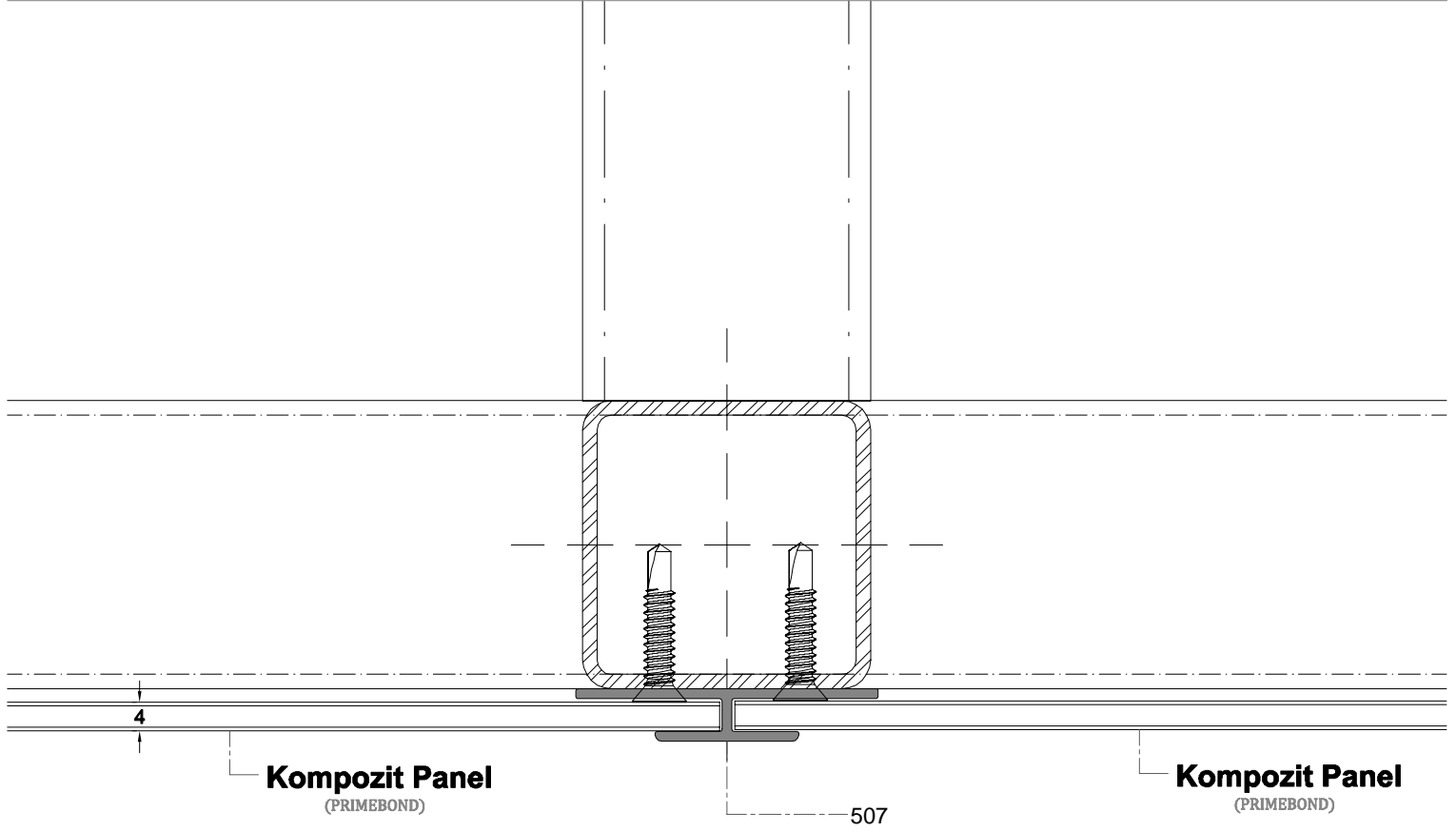

507
0.251 kg/m

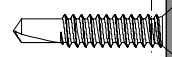
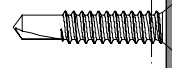
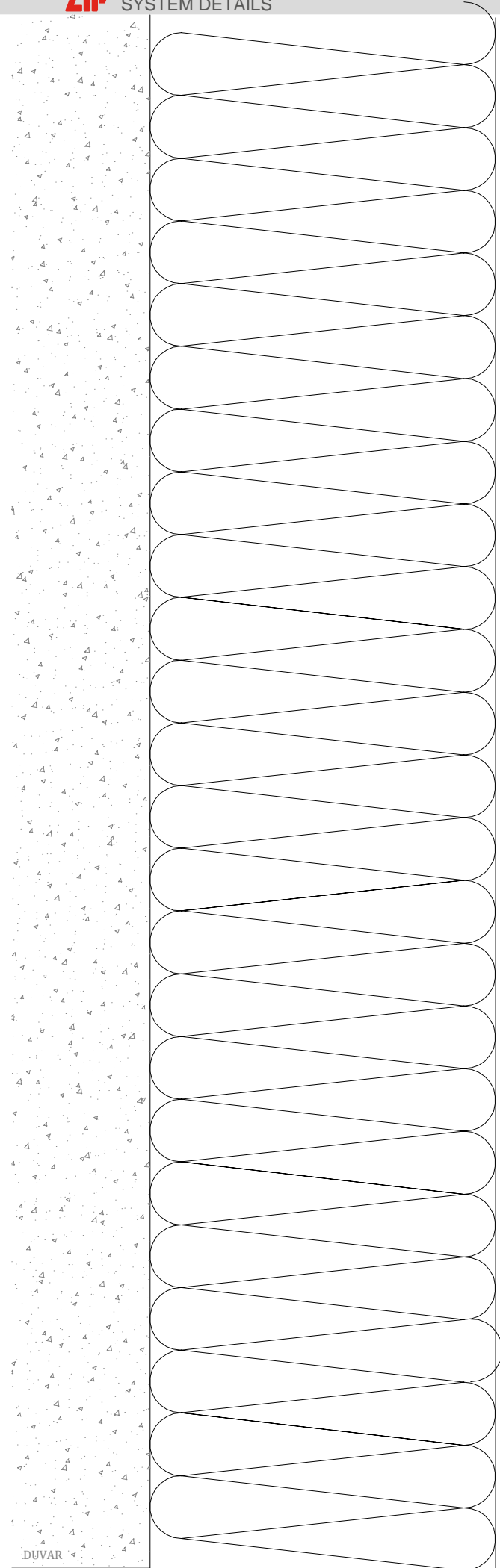

507

Kompozit Panel
(PRIMEBOND)

4

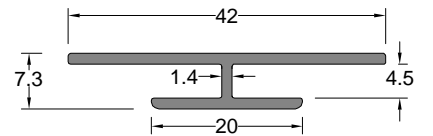

507
0.251 kg/m

DUVAR

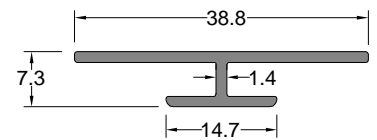
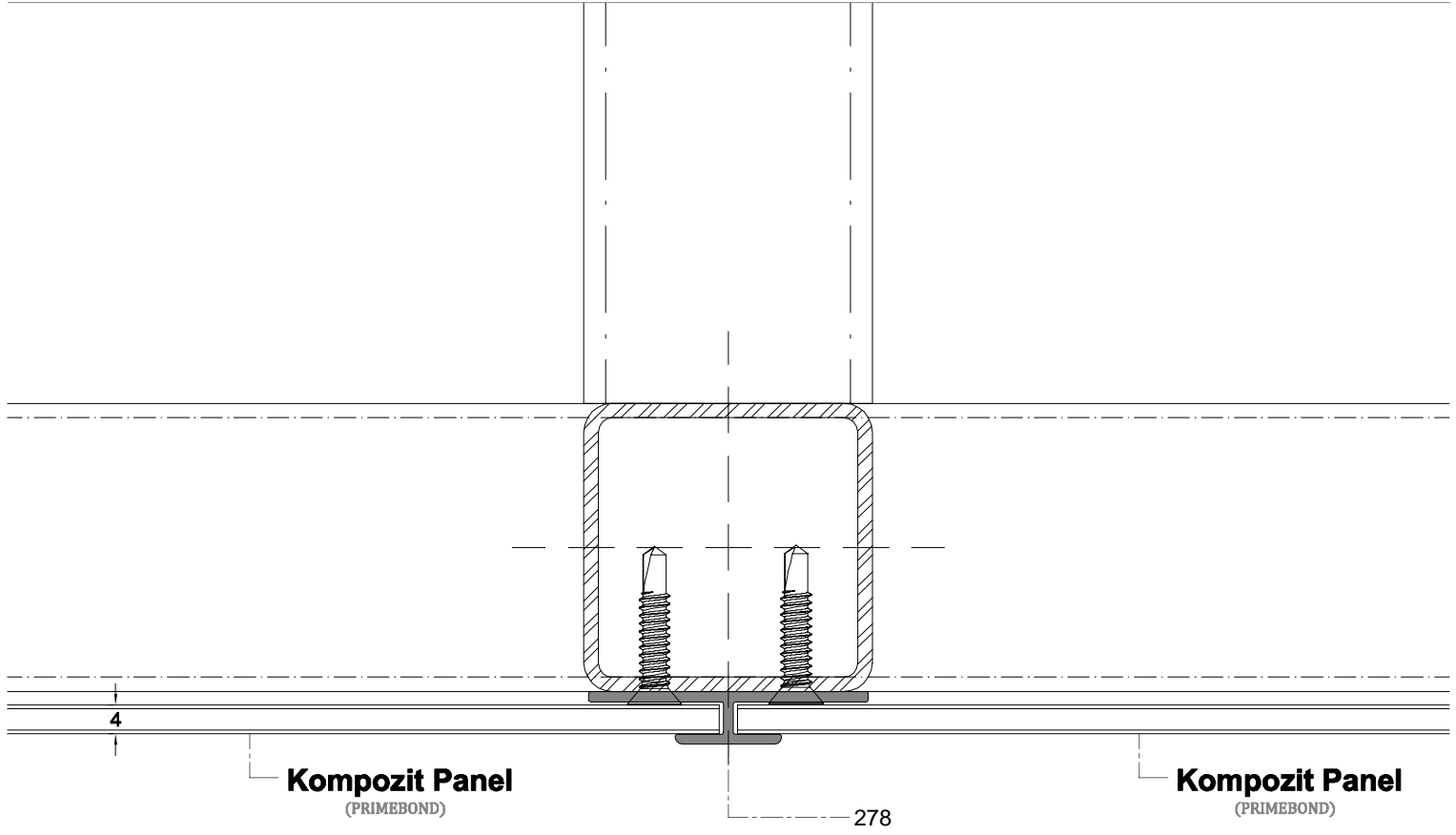

278
0.219 kg/m

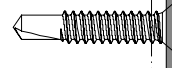
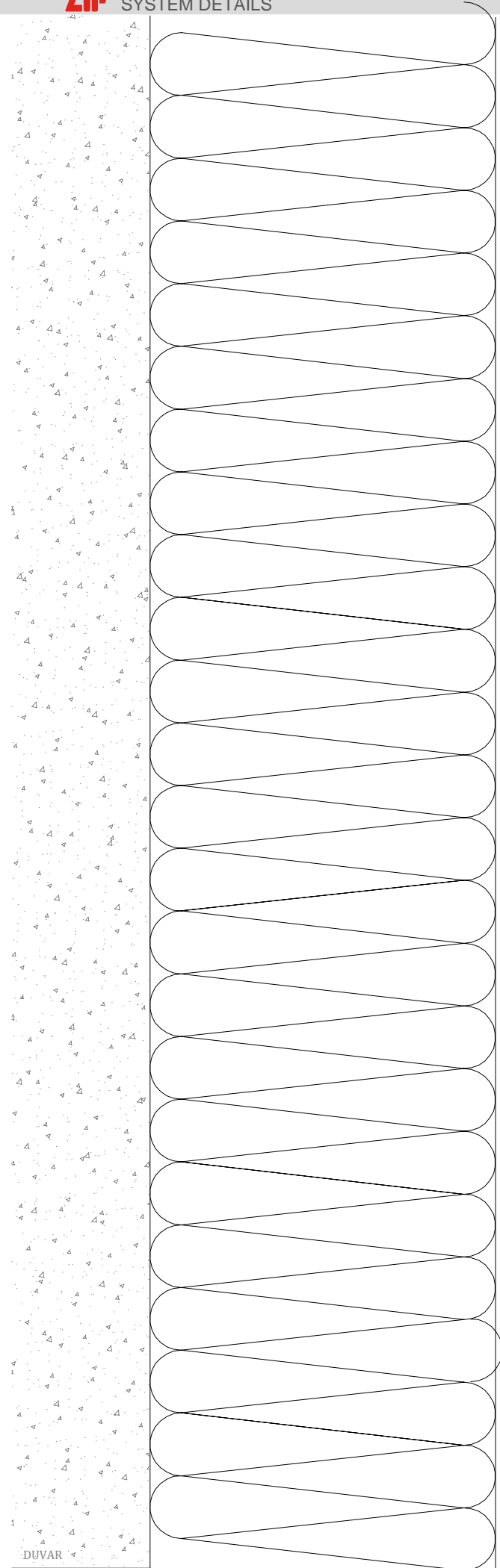

Kompozit Panel
(PRIMEBOND)

278

4

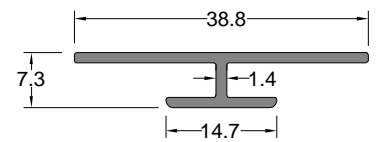

278
0.219 kg/m

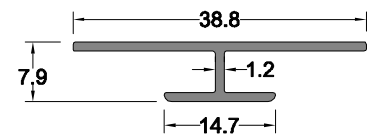
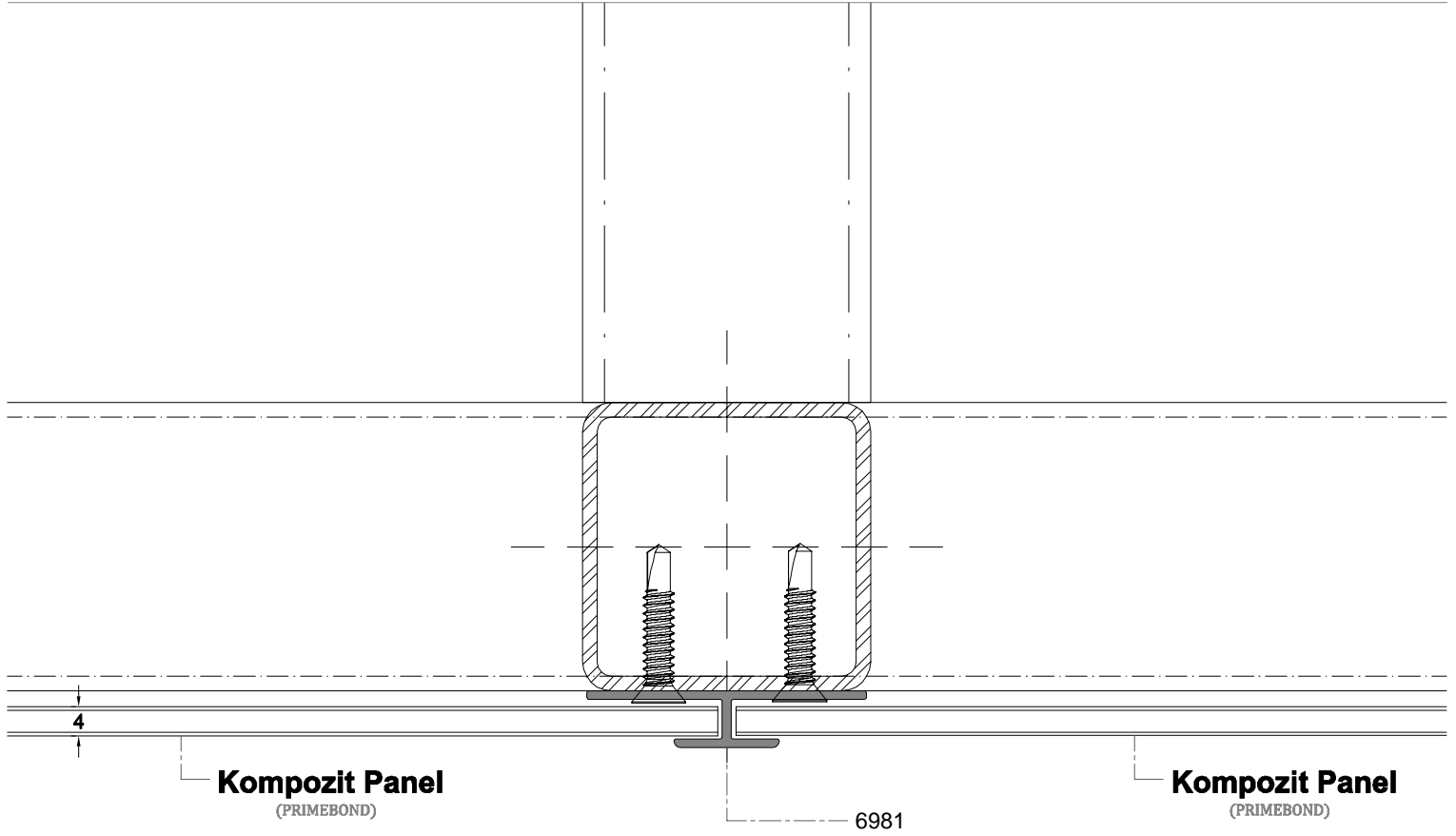

6981
0.191 kg/m

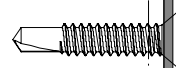
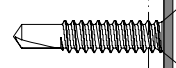
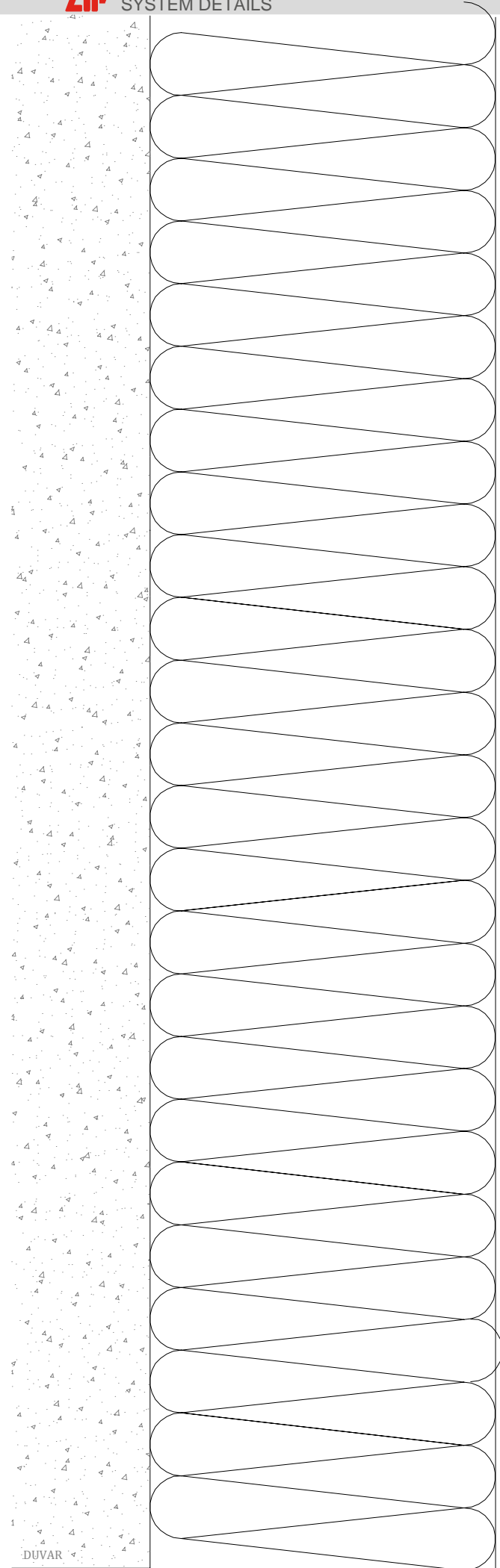

6981

Kompozit Panel
(PRIMEBOND)

4

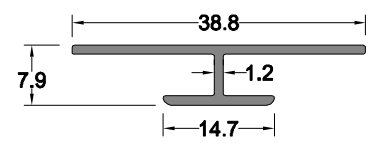

6981
0.191 kg/m

DUVAR

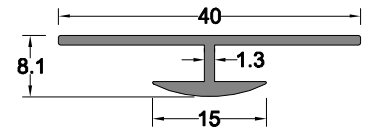
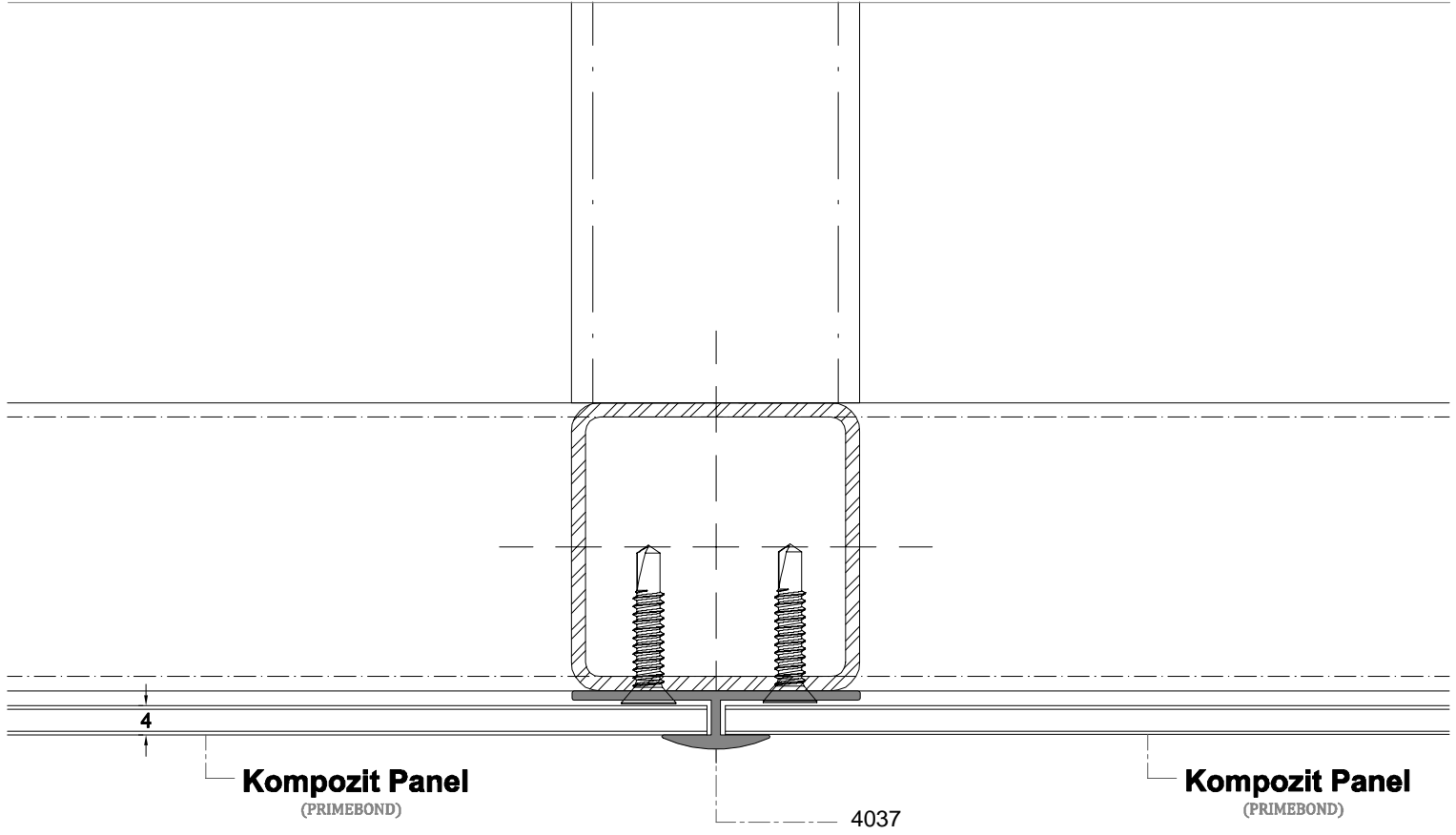

4037
0.217 kg/m

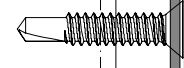
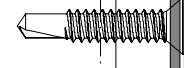
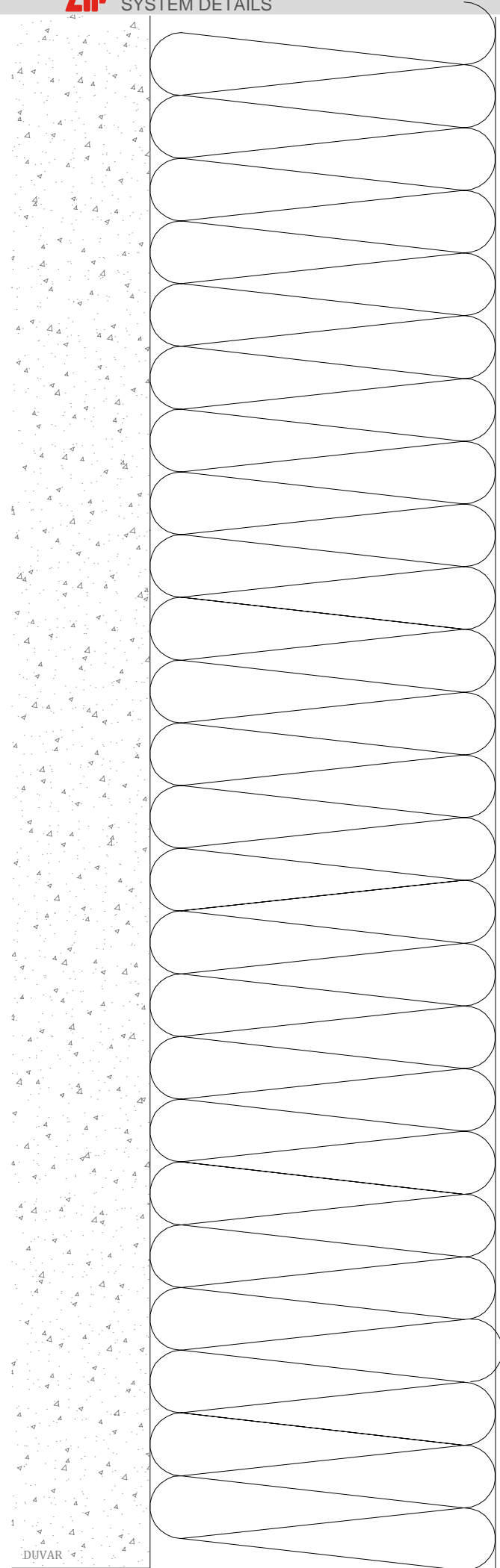

4037

Kompozit Panel
(PRIMEBOND)

4

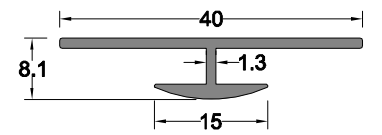

4037
0.217 kg/m

1
DUVAR

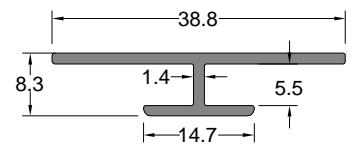
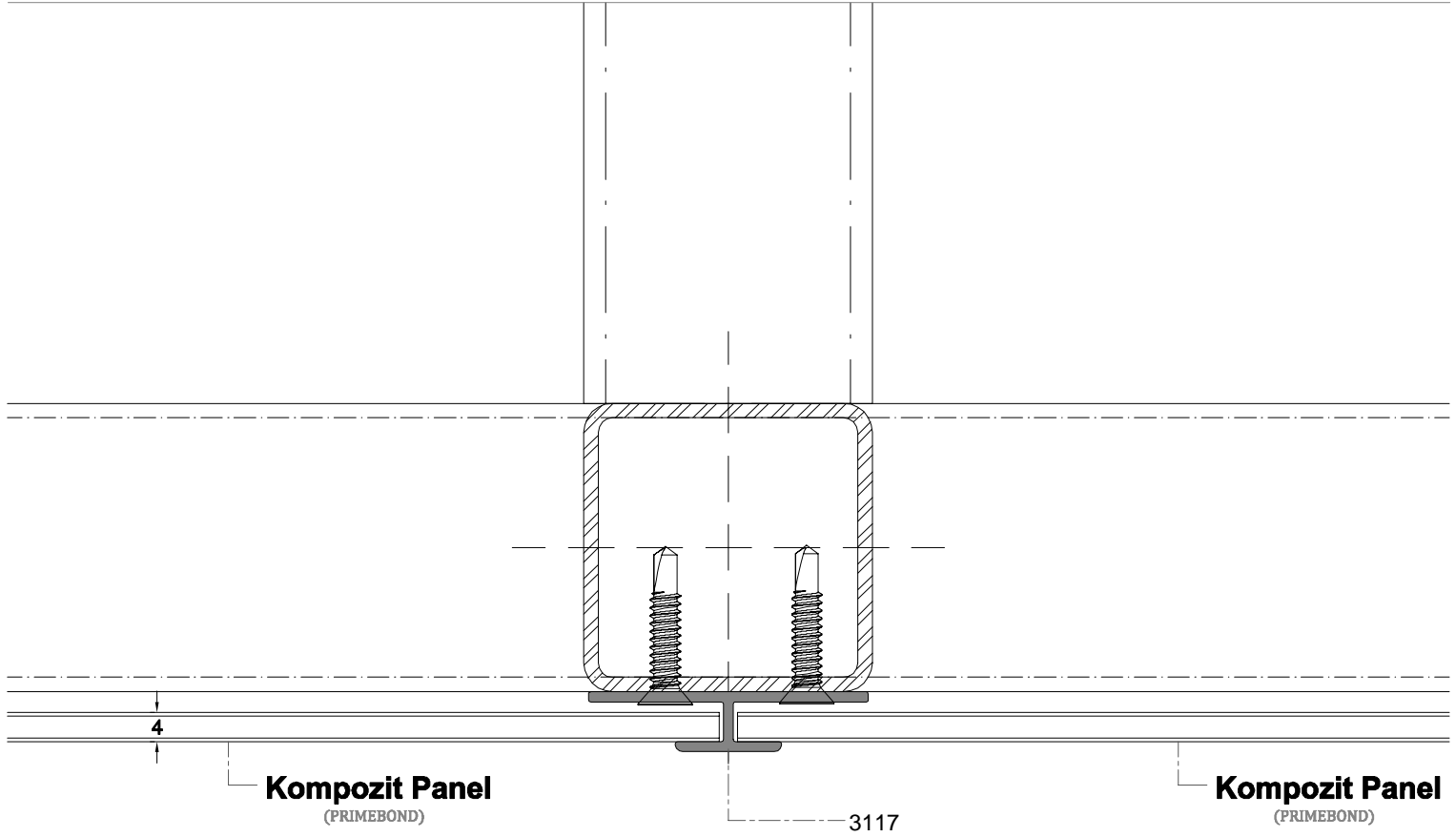

3117
0.225 kg/m

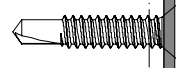
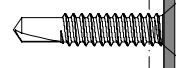
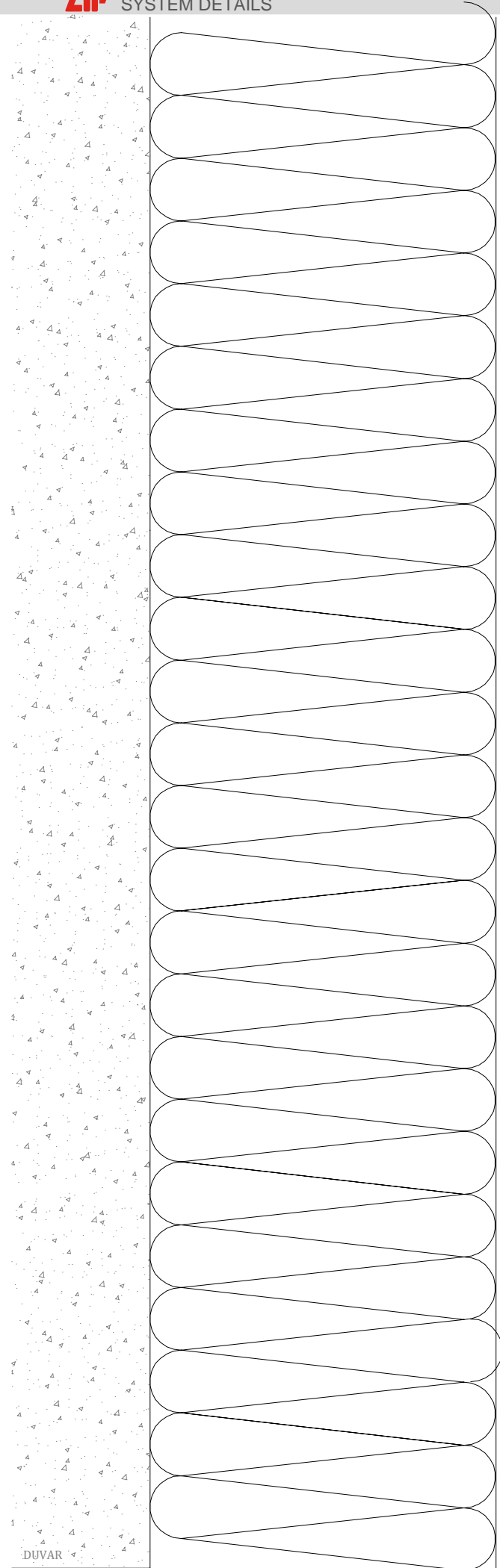

3117

Kompozit Panel
(PRIMEBOND)

4

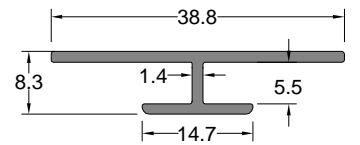

3117
0.225 kg/m

1
DUVAR

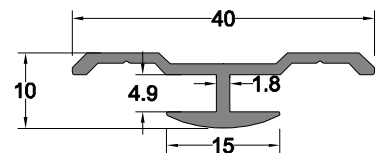
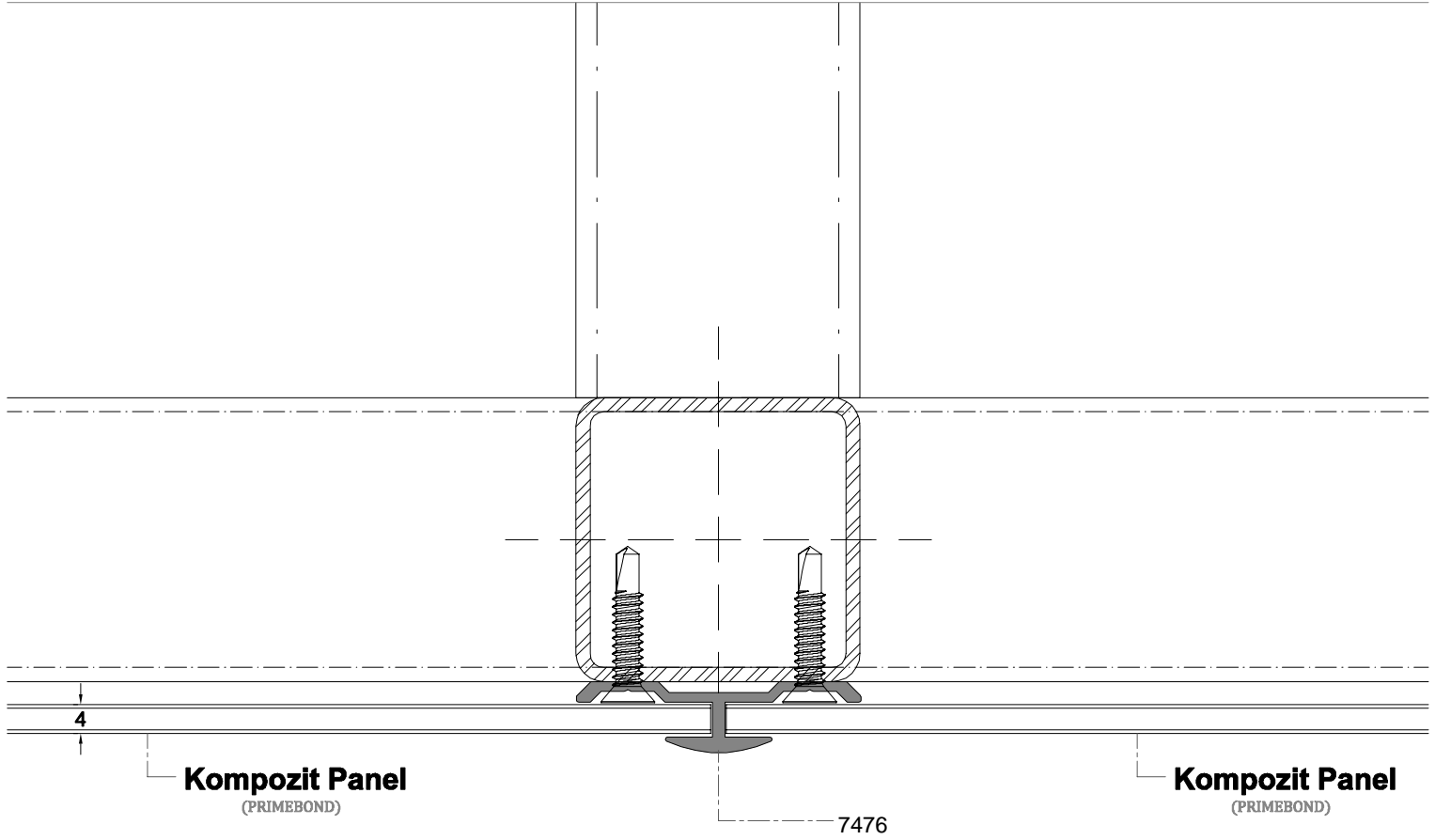

7476
0.257 kg/m

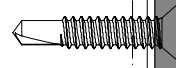
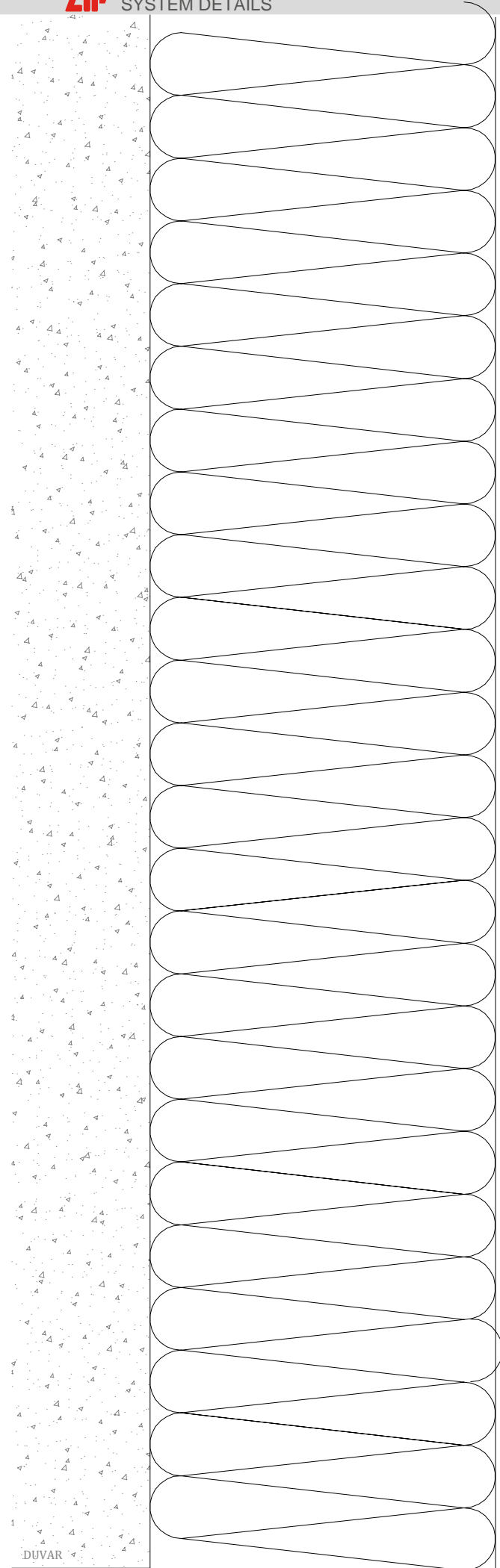

7476

Kompozit Panel
(PRIMEBOND)

4

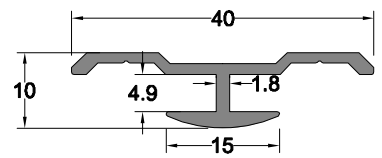

7476
0.257 kg/m

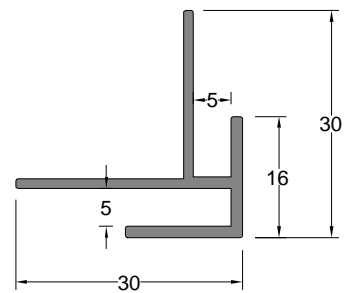
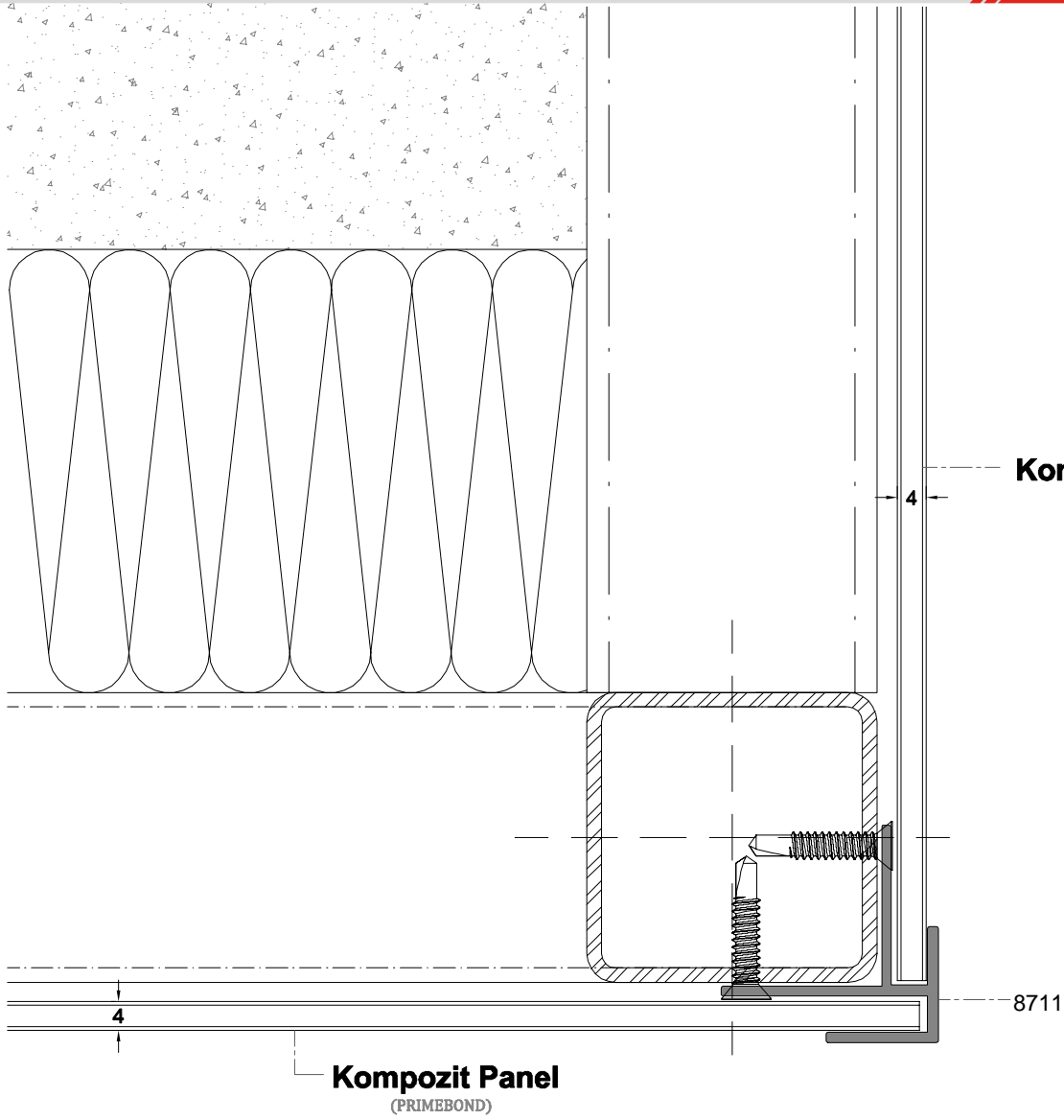

8711
0.302 kg/m

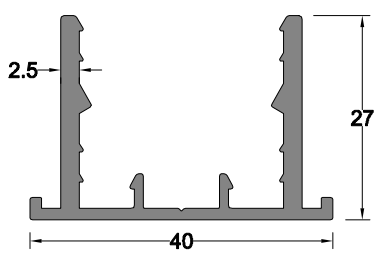
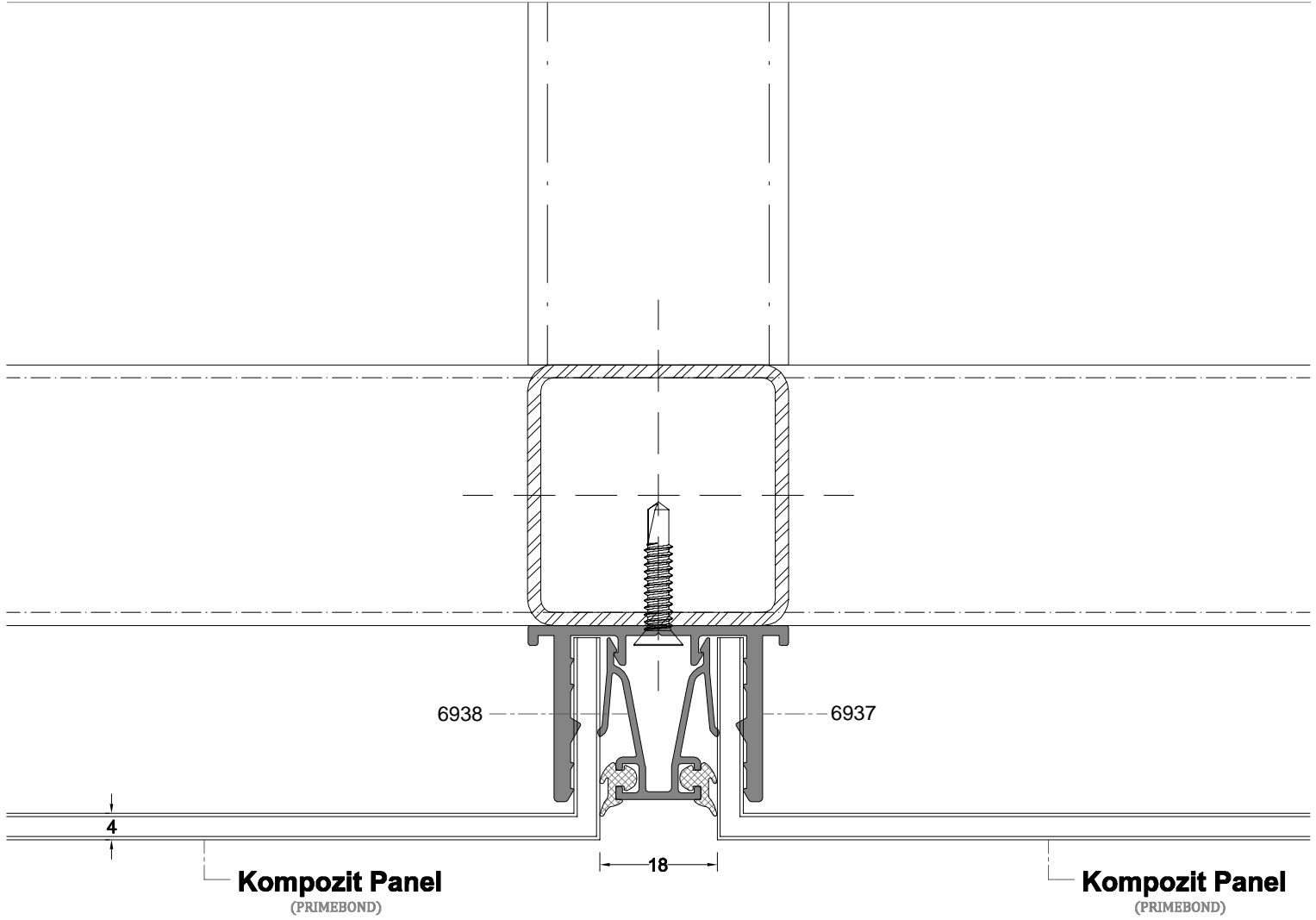

6937
0.576 kg/m

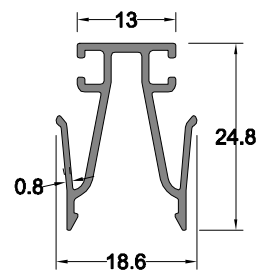

6938
0.249 kg/m

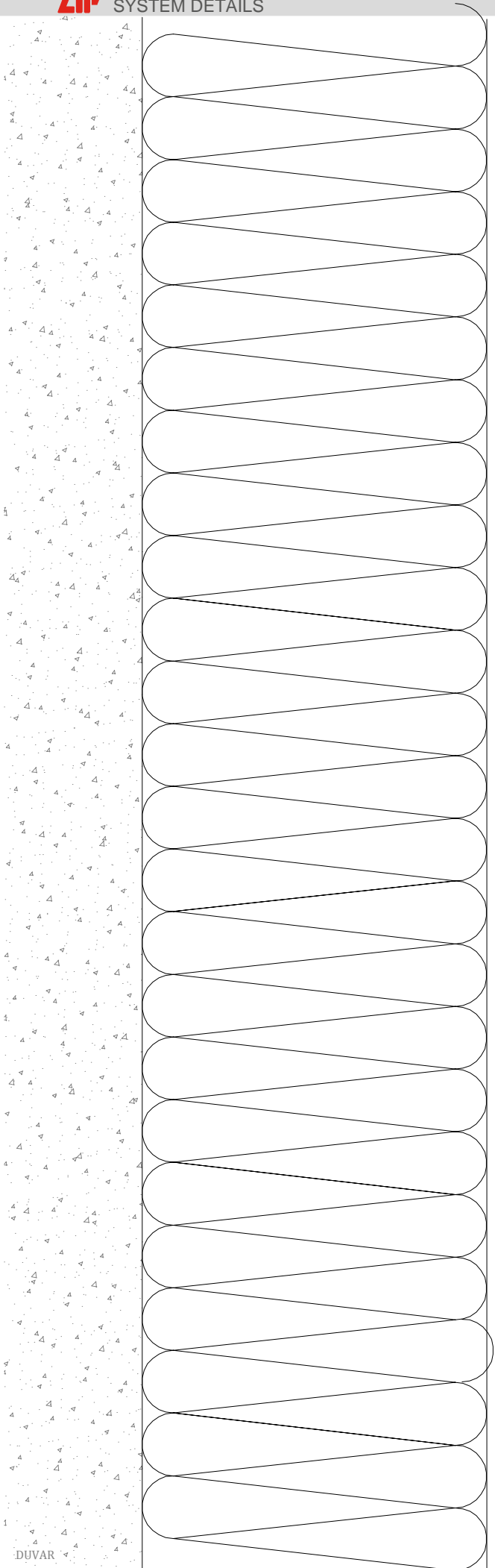

Kompozit Panel
(PRIMEBOND)

4

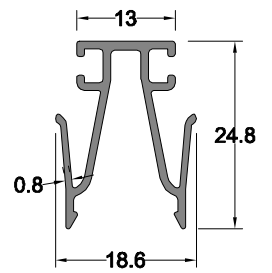

6938

0.249 kg/m

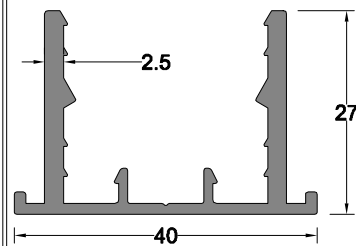

6937

0.576 kg/m

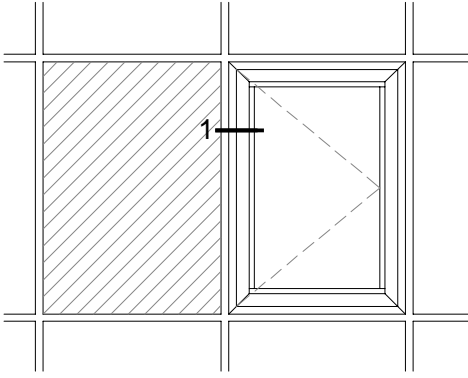

WD45 DETAYI
WD45 DETAILS

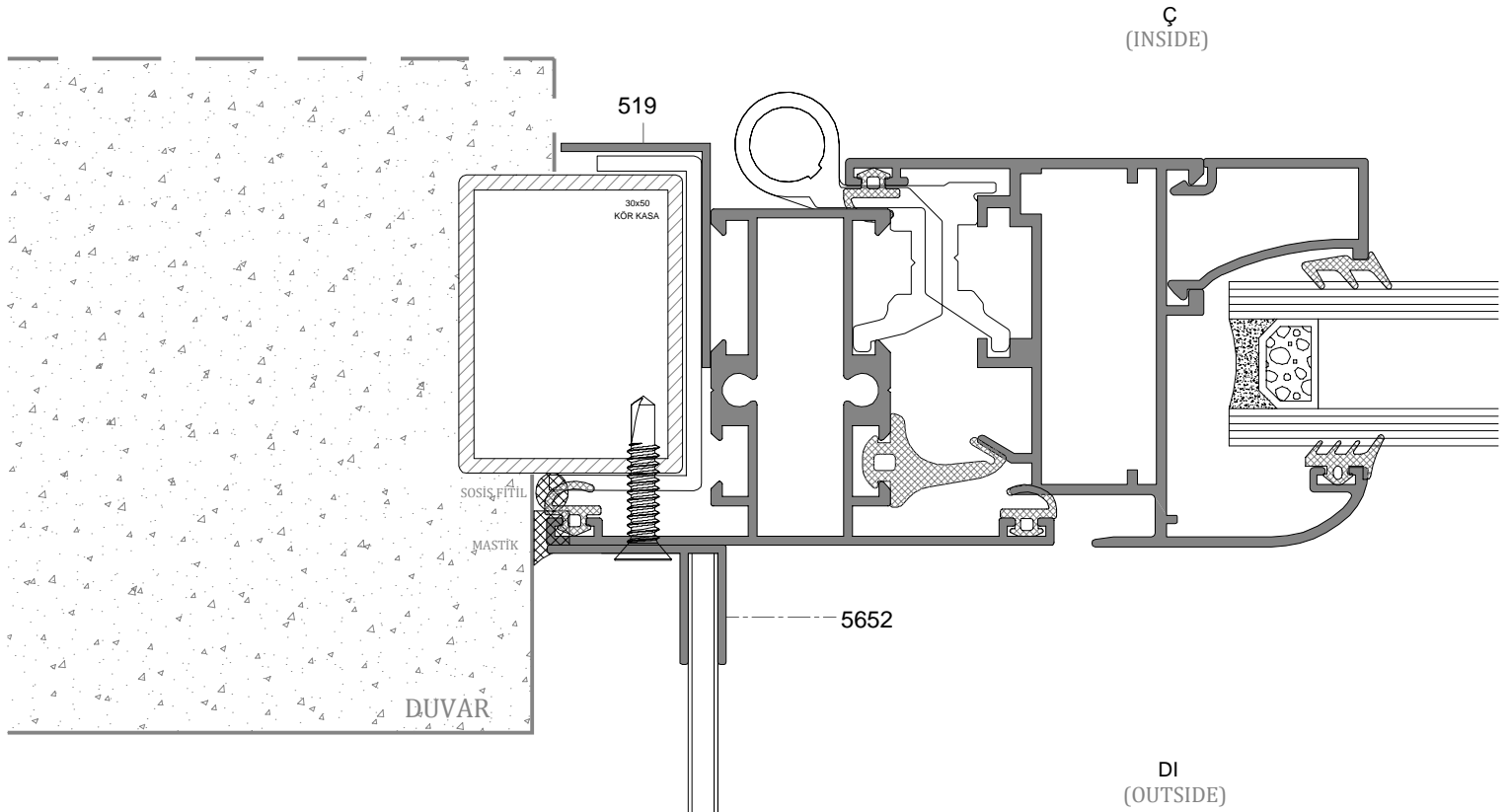

Kompozit Panel
(PRIMEBOND)

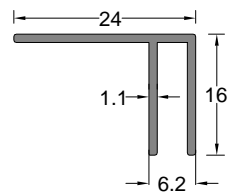

5652
0.160 kg/m

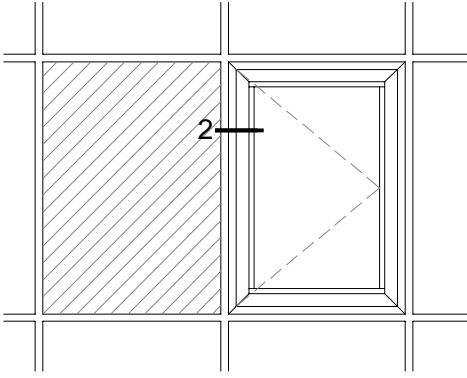

WD55 DETAYI
WD55 DETAILS

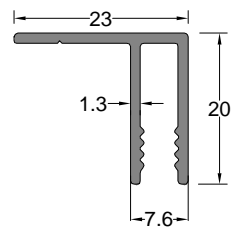
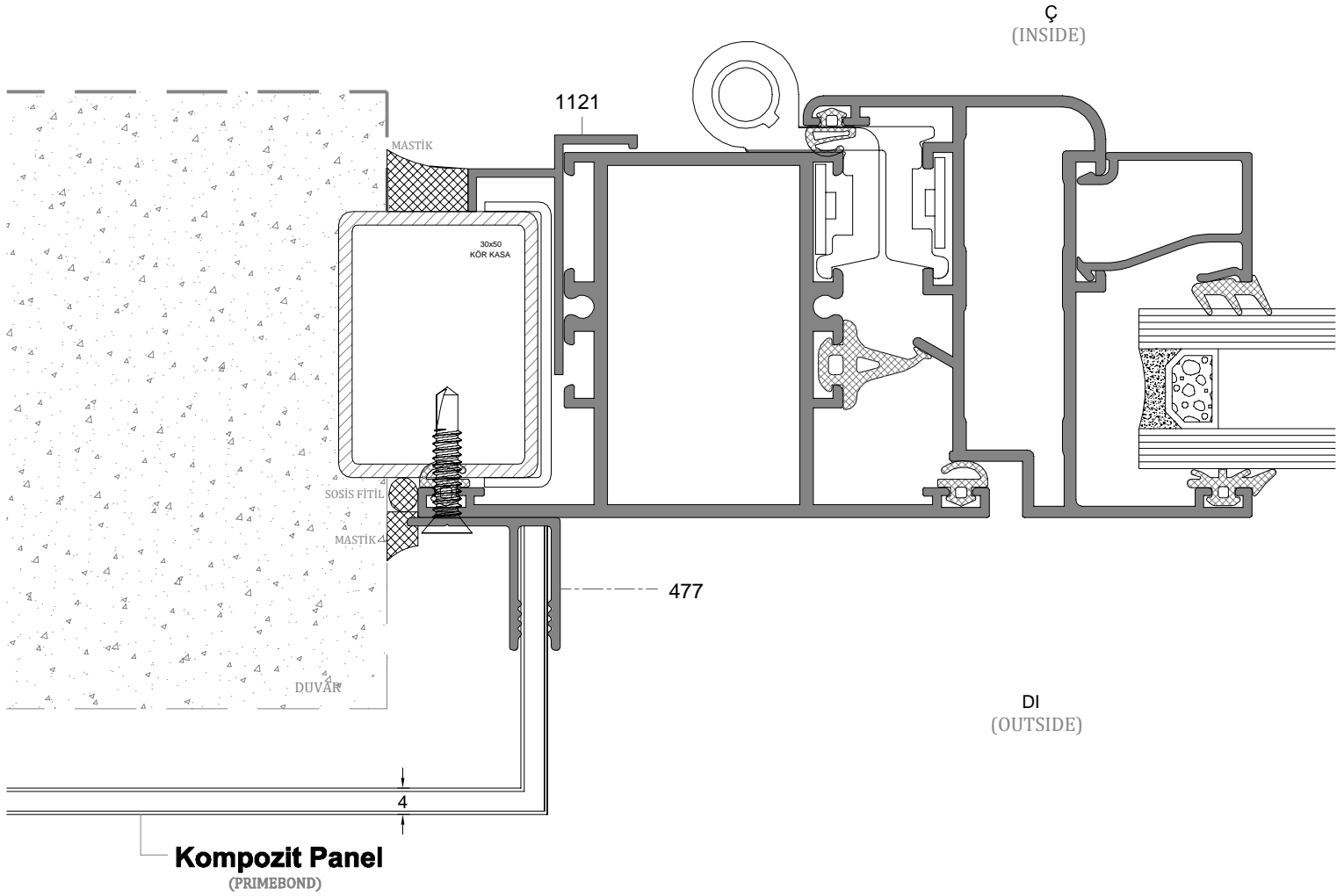

477
0.220 kg/m

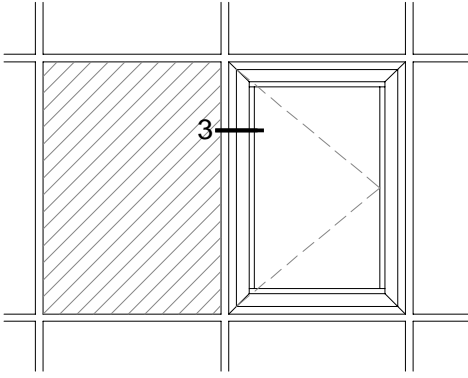

WD55T DETAYI
WD55T DETAILS

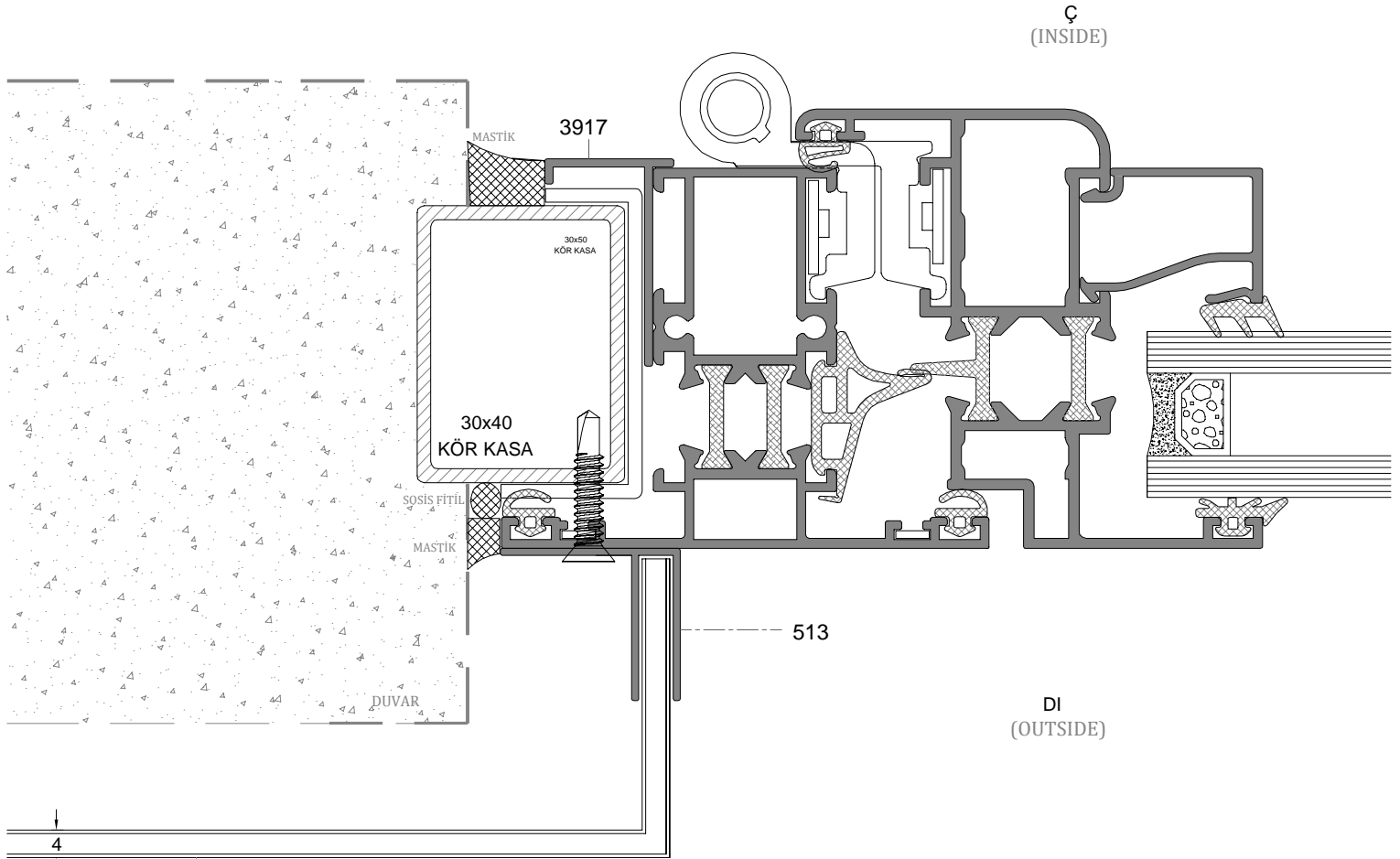

Kompozit Panel
(PRIMEBOND)

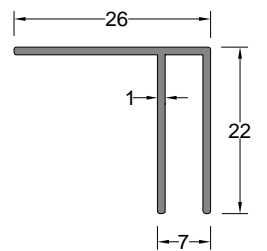

513
0.184 kg/m

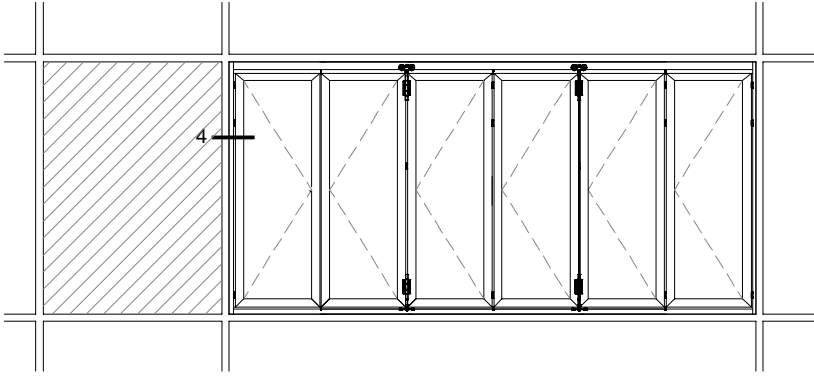

FD60T DETAYI
FD60T DETAILS

Ç
(INSIDE)

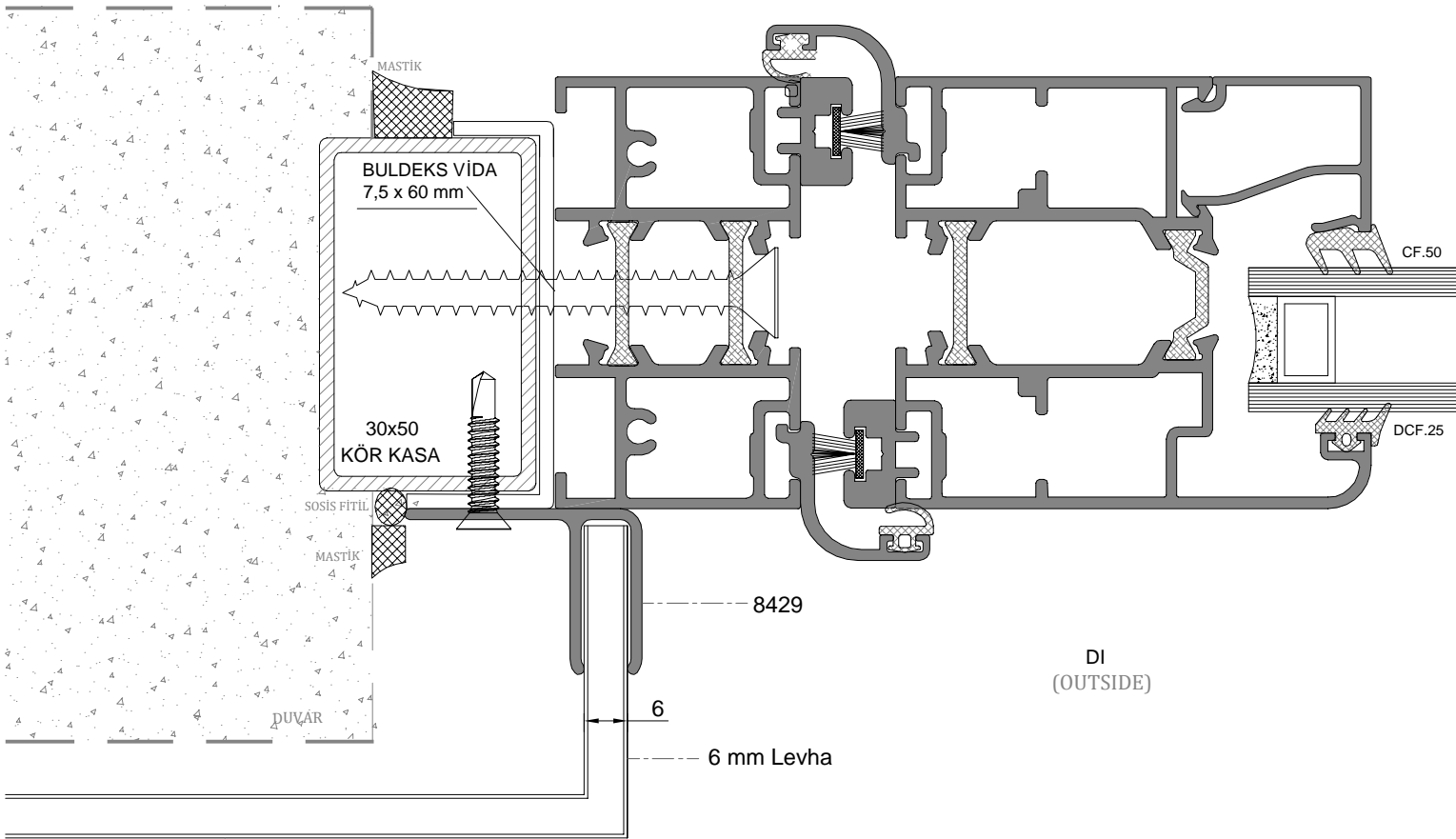

D1
(OUTSIDE)

Kompozit Panel
(PRIMEBOND)

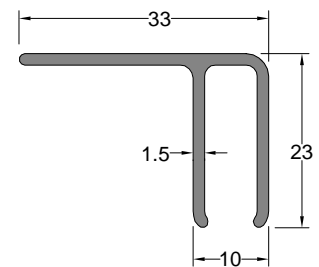

8429
0.307 kg/m

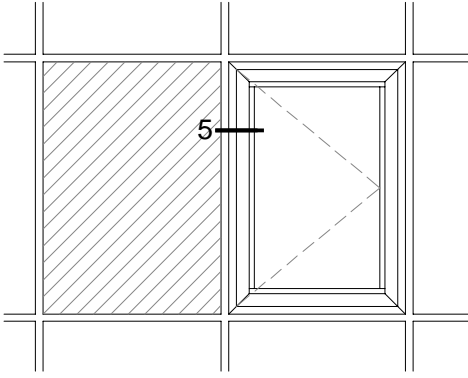

WD64T DETAYI
WD64T DETAILS

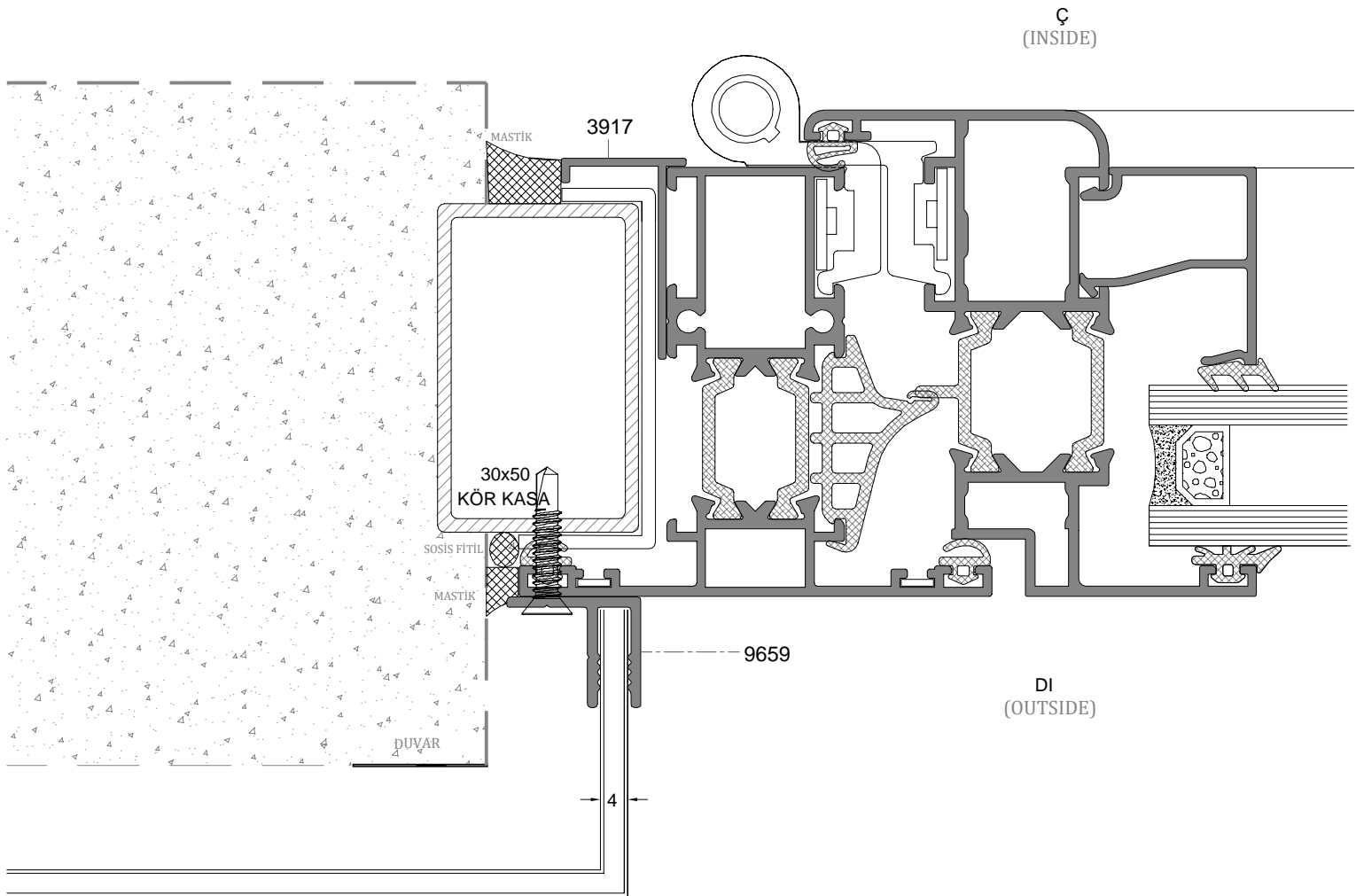

Kompozit Panel
(PRIMEBOND)

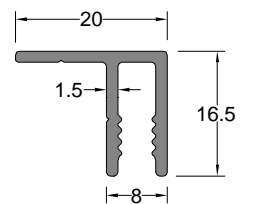

9659
0.210 kg/m

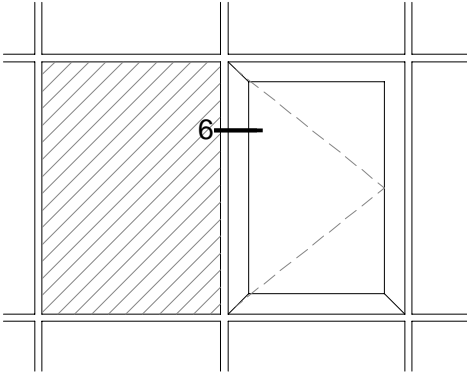

HVT67 DETAYI
HVT67 DETAILS

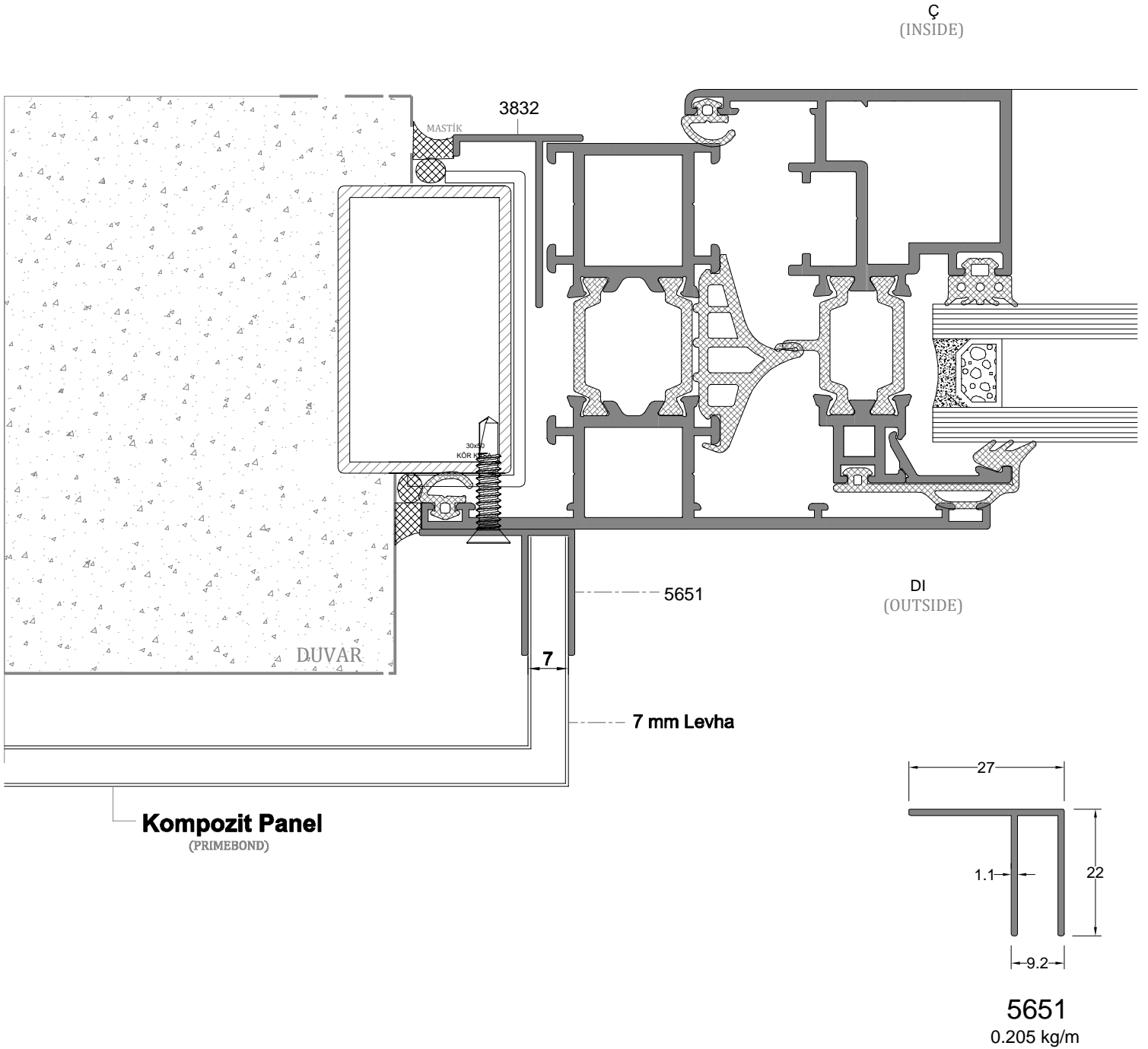

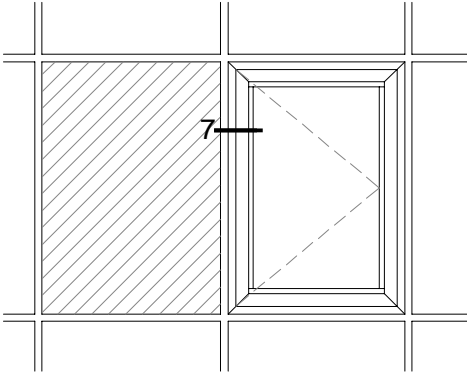

WD70T DETAYI
WD70T DETAILS

