

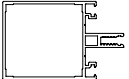

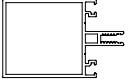













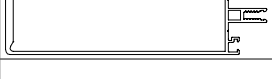

















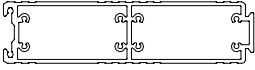
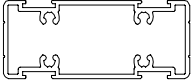

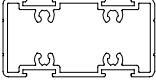
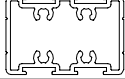
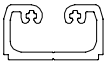

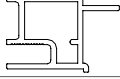
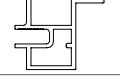

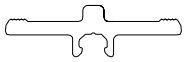

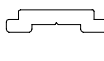

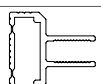

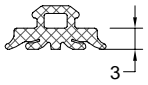
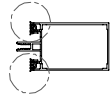
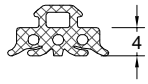
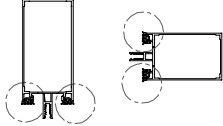
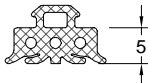
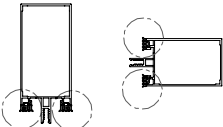
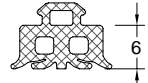
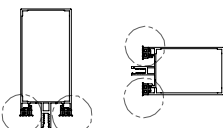
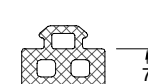
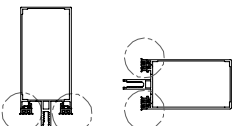
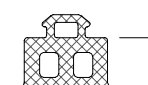
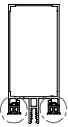
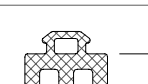
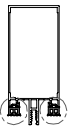
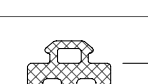
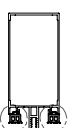
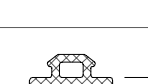
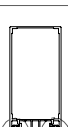
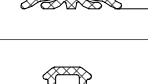

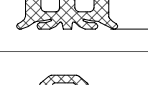
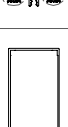
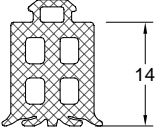
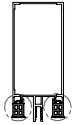
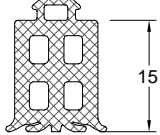
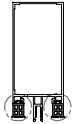
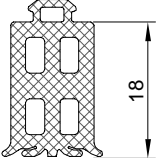
**FS-50 ECO**  
**CEPHE S STEM**  
(Facade System)

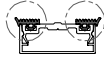
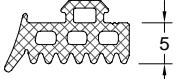
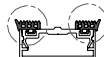
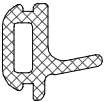
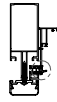
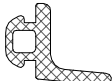
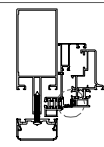
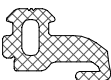
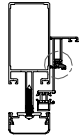
PROF L KES T PROFILE SECTION	PROF L KODU PROFILE CODE	ET KALINLIK WALL THICKNESS	PROF L ADI PROFILE NAME	Jx cm <sup>4</sup>	Jy cm <sup>4</sup>	A IRLIK (kg/m) WEIGHT
	6108	1,6 mm	60 mm DÜ EY PROF L VERTICAL PROFILE	29,28 cm <sup>4</sup>	15,70 cm <sup>4</sup>	1,334 kg/mt
	6109	2 mm	60 mm DÜ EY PROF L VERTICAL PROFILE	32,19 cm <sup>4</sup>	17,73 cm <sup>4</sup>	1,497 kg/mt
	6106	1,6 mm	80 mm DÜ EY PROF L VERTICAL PROFILE	55,74 cm <sup>4</sup>	19,45 cm <sup>4</sup>	1,507 kg/mt
	6107	2 mm	80 mm DÜ EY PROF L VERTICAL PROFILE	61,75 cm <sup>4</sup>	22,31 cm <sup>4</sup>	1,714 kg/mt
	6104	1,6 mm	100 mm DÜ EY PROF L VERTICAL PROFILE	93,12 cm <sup>4</sup>	23,19 cm <sup>4</sup>	1,681 kg/mt
	6105	2 mm	100 mm DÜ EY PROF L VERTICAL PROFILE	103,93 cm <sup>4</sup>	26,95 cm <sup>4</sup>	1,931 kg/mt
	6102	1,6 mm	120 mm DÜ EY PROF L VERTICAL PROFILE	142,77 cm <sup>4</sup>	26,93 cm <sup>4</sup>	1,854 kg/mt
	6103	2 mm	120 mm DÜ EY PROF L VERTICAL PROFILE	160,11 cm <sup>4</sup>	31,52 cm <sup>4</sup>	2,148 kg/mt
	6100	1,8 mm	150 mm DÜ EY PROF L VERTICAL PROFILE	287,96 cm <sup>4</sup>	36,26 cm <sup>4</sup>	2,421 kg/mt
	6101	2 mm	150 mm DÜ EY PROF L VERTICAL PROFILE	345,36 cm <sup>4</sup>	39,97 cm <sup>4</sup>	2,795 kg/mt
	2006	1,5 mm	19,5 mm KAPAK PROF L COVER PROFILE	-	-	0,385 kg/mt
	5123	1,2 mm	19,5 mm KAPAK PROF L COVER PROFILE	-	-	0,341 kg/mt
	5046	1,3 mm	19,5 mm KAPAK PROF L COVER PROFILE	-	-	0,334 kg/mt
	2049	1,3 mm	22 mm KAPAK PROF L COVER PROFILE	-	-	0,331 kg/mt
	2009	1,5 mm	26 mm KAPAK PROF L COVER PROFILE	-	-	0,439 kg/mt
	5045	1,3 mm	26 mm KAPAK PROF L COVER PROFILE	-	-	0,380 kg/mt
	2050	1,3 mm	33 mm KAPAK PROF L COVER PROFILE	-	-	0,430 kg/mt
	5048	1,8 mm	KAPAK ALTI PROF L SUB-COVER PROFILE	-	-	0,466 kg/mt
	5062	1,5 mm	KASET PROF L CASSETTE PROFILE	10,08 cm <sup>4</sup>	3,91 cm <sup>4</sup>	0,918 kg/mt
	5081	1,5 mm	KASET PROF L CASSETTE PROFILE	10,46 cm <sup>4</sup>	3,87 cm <sup>4</sup>	0,908 kg/mt
	5093	1,5 mm	KASET PROF L CASSETTE PROFILE	8,86 cm <sup>4</sup>	3,21 cm <sup>4</sup>	0,760 kg/mt
	5093	-	CAM YAPI TIRMA PROF L GLASS BONDING PROFILE	-	-	0,128 kg/mt

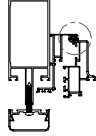

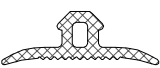
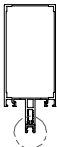
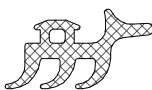
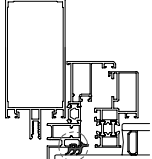

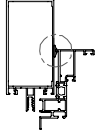
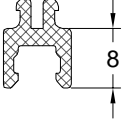
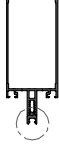
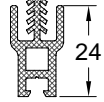
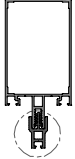
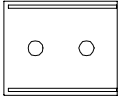
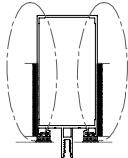
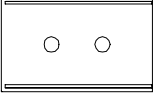
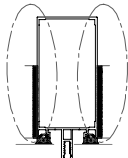
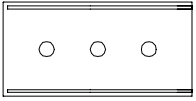
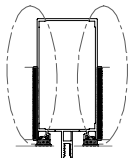
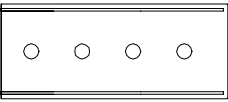
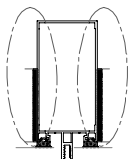
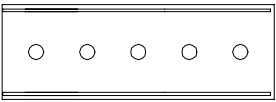
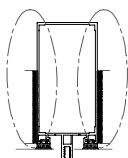
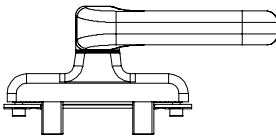

PROF L KES T PROFILE SECTION	PROF L KODU PROFILE CODE	ET KALINLIK WALL THICKNESS	PROF L ADI PROFILE NAME	Jx cm <sup>4</sup>	Jy cm <sup>4</sup>	A IRLIK (kg/m) WEIGHT
	5094	-	KASET PROF L CASSETTE PROFILE	-	-	0,340 kg/mt
	6113 - 6114	1,5 mm	KASET PROF L CASSETTE PROFILE	34,72 cm <sup>4</sup>	3,43 cm <sup>4</sup>	1,317 kg/mt
	5064 - 5066	1,8 mm	KASET PROF L CASSETTE PROFILE	30,34 cm <sup>4</sup>	6,13 cm <sup>4</sup>	1,092 kg/mt
	6110 - 6111	1,5 mm	G ZL KANAT PROF L HIDDEN SASH PROFILE	16,89 cm <sup>4</sup>	3,18 cm <sup>4</sup>	1,224 kg/mt
	6112	1,5 mm	G ZL KANAT PROF L HIDDEN SASH PROFILE	15,20 cm <sup>4</sup>	3,06 cm <sup>4</sup>	0,985 kg/mt
	5129	-	D LATASYON PROF L DILATATION PROFILE	-	-	4,655 kg/mt
	6123	-	D LATASYON PROF L DILATATION PROFILE	-	-	2,753 kg/mt
	6122	-	D LATASYON PROF L DILATATION PROFILE	-	-	3,119 kg/mt
	6125	-	D LATASYON PROF L DILATATION PROFILE	-	-	2,484 kg/mt
	6124	-	D LATASYON PROF L DILATATION PROFILE	-	-	2,199 kg/mt
	5042	-	BA LANTI PROF L CONNECTION PROFILE	-	-	1,144 kg/mt
	6121	-	BA LANTI PROF L CONNECTION PROFILE	-	-	2,027 kg/mt
	6115	-	TEK CAM KASET PROF L SINGLE GLASS CASSETTE PROFILE	-	-	0,411 kg/mt
	6116	-	TEK CAM KASET PROF L SINGLE GLASS CASSETTE PROFILE	-	-	0,530 kg/mt
	6118	-	CAM ÇITA KL PS PROF L GLASS BEAD CLIP PROFILE	-	-	0,262 kg/mt
	6119	-	CAM ÇITA KL PS PROF L GLASS BEAD CLIP PROFILE	-	-	0,407 kg/mt
	9748	-	CAM ÇITA KL PS PROF L GLASS BEAD CLIP PROFILE	-	-	0,419 kg/mt
	1122	-	T J PROF L STEM BAR PROFILE	-	-	0,157 kg/mt
	6120	-	CAM ALTI TAKOZ PROF L SUB-GLASS WEDGE PROFILE	-	-	0,265 kg/mt
	6117	-	CAM ALTI TAKOZ PROF L SUB-GLASS WEDGE PROFILE	-	-	0,250 kg/mt
	1662	-	KÖ E TAKOZ PROF L CORNER WEDGE PROFILE	-	-	2,591 kg/mt
	5022	-	KÖ E TAKOZ PROF L CORNER WEDGE PROFILE	-	-	2,370 kg/mt

AKSESUAR ACCESSORY	STOK KODU REFERENCE CODE	AKSESUAR ADI DESCRIPTION	AKSESUAR KODU PRODUCT CODE		PAKET PACK
	03 010103	CEPHE CAM F T L GLASS GASKET	CF.03 (3 MM)		165 mt / paket 10 kg
	03 010104	CEPHE CAM F T L GLASS GASKET	CF.04 (4 MM)		145 mt / paket 10 kg
	03 010105	CEPHE CAM F T L GLASS GASKET	CF.05 (5 MM)		120 mt / paket 10 kg
	03 010116	CEPHE CAM F T L GLASS GASKET	CF.06 (6 MM)		105 mt / paket 10 kg
	03 010107	CEPHE CAM F T L GLASS GASKET	CF.07 (7 MM)		95 mt / paket 10 kg
	03 010108	CEPHE CAM F T L GLASS GASKET	CF.08 (8 MM)		85 mt / paket 10 kg
	03 010109	CEPHE CAM F T L GLASS GASKET	CF.09 (9 MM)		80 mt / paket 10 kg/mt
	03 011010	CEPHE CAM F T L GLASS GASKET	CF.10 (10 MM)		75 mt / paket 10 kg
	03 011011	CEPHE CAM F T L GLASS GASKET	CF.11 (11 MM)		70 mt / paket 10 kg
	03 010112	CEPHE CAM F T L GLASS GASKET	CF.12 (12 MM)		65 mt / paket 10 kg
	03 010113	CEPHE CAM F T L GLASS GASKET	CF.13 (12 MM)		60 mt / paket 10 kg

AKSESUAR ACCESSORY	STOK KODU REFERENCE CODE	AKSESUAR ADI DESCRIPTION	AKSESUAR KODU PRODUCT CODE		PAKET PACK
	03 010114	CEPHE CAM F T L GLASS GASKET	CF.14 (14 MM)		165 mt / paket 10 kg
	03 010115	CEPHE CAM F T L GLASS GASKET	CF.15 (15 MM)		145 mt / paket 10 kg
	03 010117	CEPHE CAM F T L GLASS GASKET	CF.18 (18 MM)		... mt / paket 10 kg
	03 010606	KAPAK ALTI DI CAM F T L GLASS GASKET	KF.30 (3 MM)		135 mt / paket 10 kg
	03 010607	KAPAK ALTI DI CAM F T L GLASS GASKET	KF.50 (5 MM)		105 mt / paket 10 kg
	03 010441	CEPHE Ç KASA DERZ F T L GASKET	KTF.20		175 mt / paket 10 kg
	03 010220	CEPHE Ç KASET DERZ F T L	TF.20		140 mt / paket 10 kg/mt
	03 010611	CEPHE G ZL KANAT KASA F T L	KYF.10		115 mt / paket 10 kg
	03 015556	CEPHE ORTA BASKI F T L	KYF.03		215 mt / paket 10 kg
 ÖLÇEK:1/2	03 010326	KAPAK ALTI DI CAM F T L GLASS GASKET	BKF.30		52 mt / paket 10 kg
	03 010325	KAPAK ALTI DI CAM F T L GLASS GASKET	STF.30		159 mt / paket 10 kg
	03 010330	KAPAK ALTI DI CAM F T L GLASS GASKET	CYF.10		105 mt / paket 10 kg

AKSESUAR	STOK KODU REFERENCE CODE	AKSESUAR ADI DESCRIPTION	AKSESUAR KODU PRODUCT CODE		PAKET PACK
	03 070106	2 MM KAMA F T L GLASS GASKET	KMF.02		
	31 020413	CEPHE ISI ZOLATÖR	PLS.08		60 mt / paket 10 kg
 ÖLÇEK:1/2	01 071061	CEPHE ISI ZOLATÖR	PLS.15		60 mt / paket 10 kg
 ÖLÇEK:1/4	03 070445	GENLE ME YAKASI (EPDM)  6108 ve 6109 NOLU PROF LLER Ç N	GY.60		100 ad / paket
 ÖLÇEK:1/4	03 070450	GENLE ME YAKASI (EPDM)  6106 ve 6107 NOLU PROF LLER Ç N	GY.80		100 ad / paket
 ÖLÇEK:1/4	03 070451	GENLE ME YAKASI (EPDM)  6104 ve 6105 NOLU PROF LLER Ç N	GY.100		100 ad / paket
 ÖLÇEK:1/4	03 070452	GENLE ME YAKASI (EPDM)  6102 ve 6103 NOLU PROF LLER Ç N	GY.120		100 ad / paket
 ÖLÇEK:1/4	03 070455	GENLE ME YAKASI (EPDM)  6100 ve 6101 NOLU PROF LLER Ç N	GY.150		100 ad / paket
	01 100402	GIESSE CEPHE KOLU(BEYAZ)	GCK-402		1 ad / paket
	01 100405	GIESSE CEPHE KOLU(S YAH)	GCK-400		
	01 100409	GIESSE CEPHE MAKAS( GR )	GCK-409		

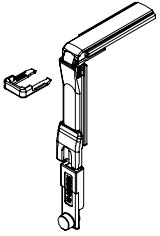
AKSESUAR ACCESSORY	STOK KODU REFERENCE CODE	AKSESUAR ADI DESCRIPTION	AKSESUAR KODU PRODUCT CODE	PAKET PACK
	01 020881	FORZA BÜKÜMLÜ CEPHE KOLU (BEYAZ)	FCK.881	1 ad / paket
	01 020882	FORZA BÜKÜMLÜ CEPHE KOLU (S YAH)	FCK.882	
	01 020880	FORZA BÜKÜMLÜ CEPHE KOLU (NATUREL)	FCK.880	
	01 120205	CEPHE P M KAR ILIK		100 ad / paket
	01 120200	SPANYOLET P M		100 ad / paket
	08 100103	NORTON BANT		50 Mt / paket
	03 060101	POL ÜRETAN DOLGU SOS S		450 Mt / paket
	08 040230	DERZ S L KON		24 ad / paket
	01 100200	C VATA, SOMUN VE RONDELA	M10 X 90	300 ad / Paket
	01 100121	HAREKETL VE SAB T ANKRAJ 80 MM		20 ad / paket
	01 100116	HAREKETL VE SAB T ANKRAJ 100 MM		20 ad / paket
	01 100117	HAREKETL VE SAB T ANKRAJ 120 MM		20 ad / paket

AKSESUAR ACCESSORY	STOK KODU REFERENCE CODE	AKSESUAR ADI DESCRIPTION	AKSESUAR KODU PRODUCT CODE	PAKET PACK
	11 010937	YSB SAÇ V DASI M4.8 X 25 MM		250 ad / paket
	11 010944	YSB SAÇ V DASI M4.8 X 32 MM		250 ad / paket
	11 010940	YSB SAÇ V DASI M4.8 X 45 MM		250 ad / paket
	11 010941	YSB SAÇ V DASI M4.8 X 50 MM		250 ad / paket
	11 010942	YSB SAÇ V DASI M4.8 X 60 MM		250 ad / paket
	01 100816	HAREKET TRANSFER KÖŞE PARÇASI		
	01 120222	T J BA LANTI PARÇASI		100 ad / paket

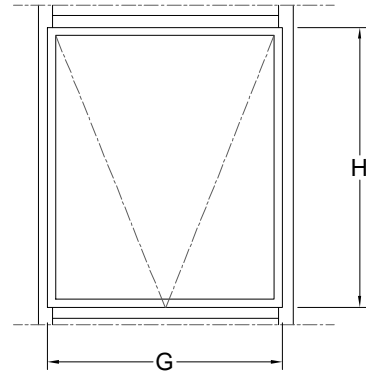
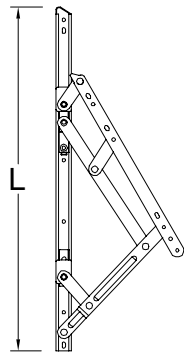

STOK KODU REFERENCE CODE	MAKAS BOYU (L) REFERENCE CODE		MAX.AÇILMA DERECE (X) REFERENCE CODE	MAX.KANAT YÜKSEKLİK (G) MAX. SASH HEIGHT	MAX.KANAT GENİŞLİK (G) MAX. SASH WIDTH	MAX.KANAT AĞIRLIK MAX. SASH WEIGHT
01 100447	10"	261,5 mm	35 °	700 mm	1200 mm	50 kg
01 100448	12"	317,5 mm	30 / 35 °	800 mm	1200 mm	60 kg
01 100449	14"	353,5 mm	30 / 35 °	1000 mm	1300 mm	69,5 kg
01 100450	16"	414,5 mm	30 / 35 °	1200 mm	1400 mm	88,5 kg
01 100451	18"	458,5 mm	25 / 30 °	1400 mm	1400 mm	102 kg
01 100452	20"	511,5 mm	25 / 30 °	1600 mm	1500 mm	135 kg
01 100453	22"	556,5 mm	20 / 25 °	1700 mm	1500 mm	137 kg
01 100454	24"	602,5 mm	20 / 25 °	1800 mm	1500 mm	139 kg
01 100455	28"	707,5 mm	10/15/20 °	2000 mm	1500 mm	155 kg



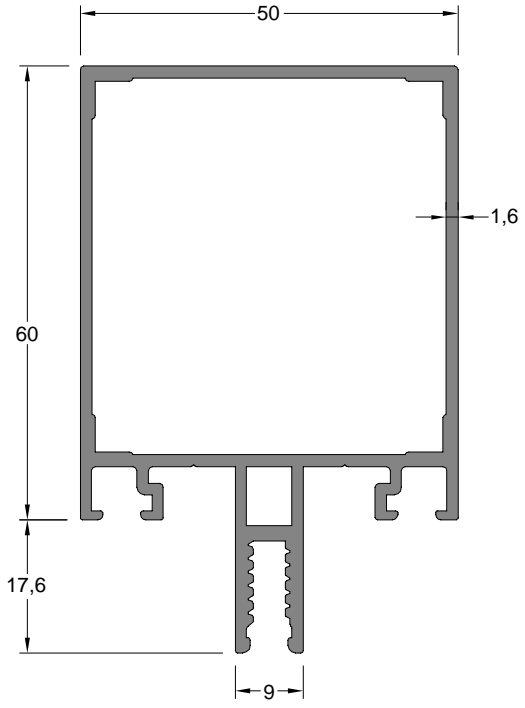
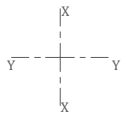

Dü ey Profili	Profil Kodu	(kg/mt)	Jx cm <sup>4</sup>	Jy cm <sup>4</sup>
VERTICAL PROFILE	6108	1,334	29,28	15,70

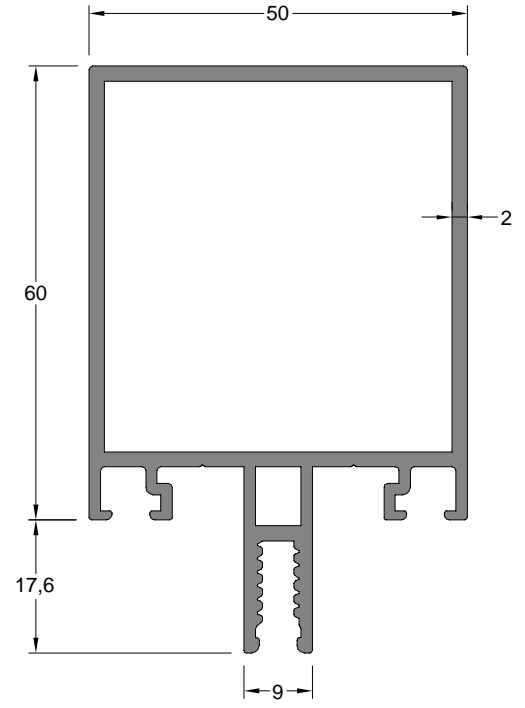

Dü ey Profili	Profil Kodu	(kg/mt)	Jx cm <sup>4</sup>	Jy cm <sup>4</sup>
VERTICAL PROFILE	6109	1,497	32,19	17,73

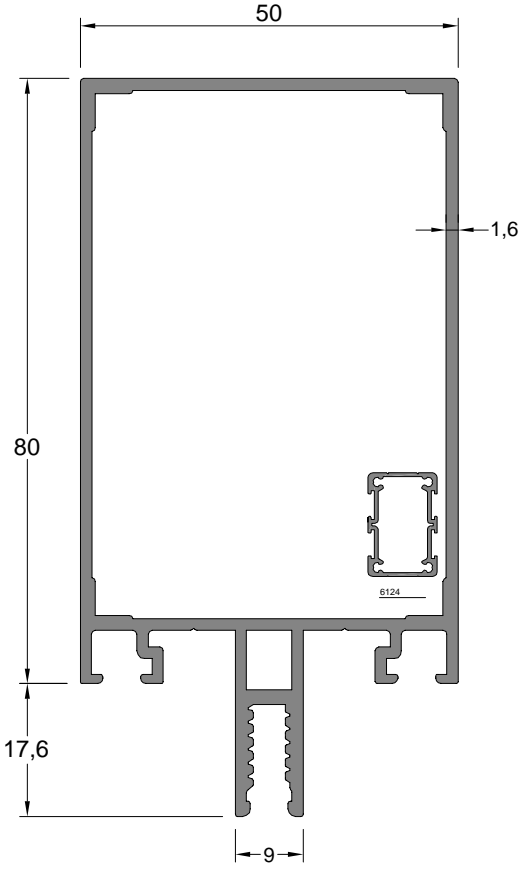

Dü ey Profili	Profil Kodu	(kg/mt)	Jx cm <sup>4</sup>	Jy cm <sup>4</sup>
VERTICAL PROFILE	6106	1,507	55,74	19,45

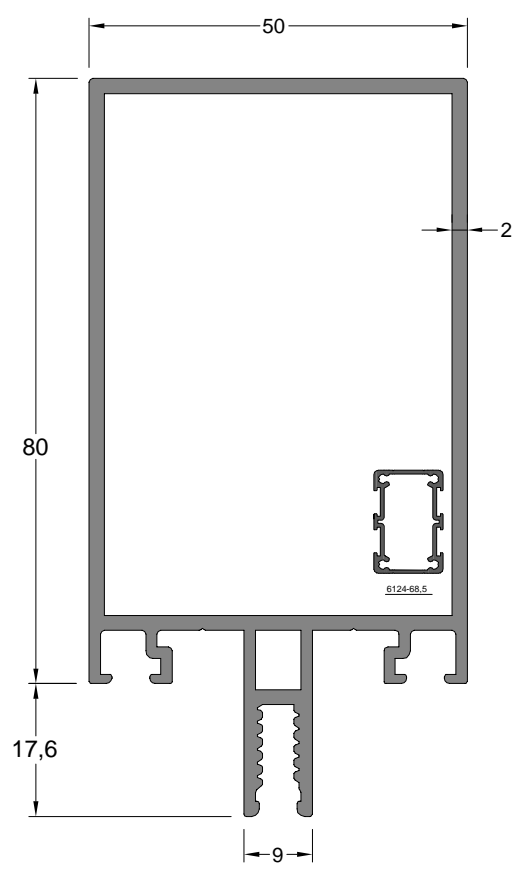

Dü ey Profili	Profil Kodu	(kg/mt)	Jx cm <sup>4</sup>	Jy cm <sup>4</sup>
VERTICAL PROFILE	6107	1,714	61,75	22,31

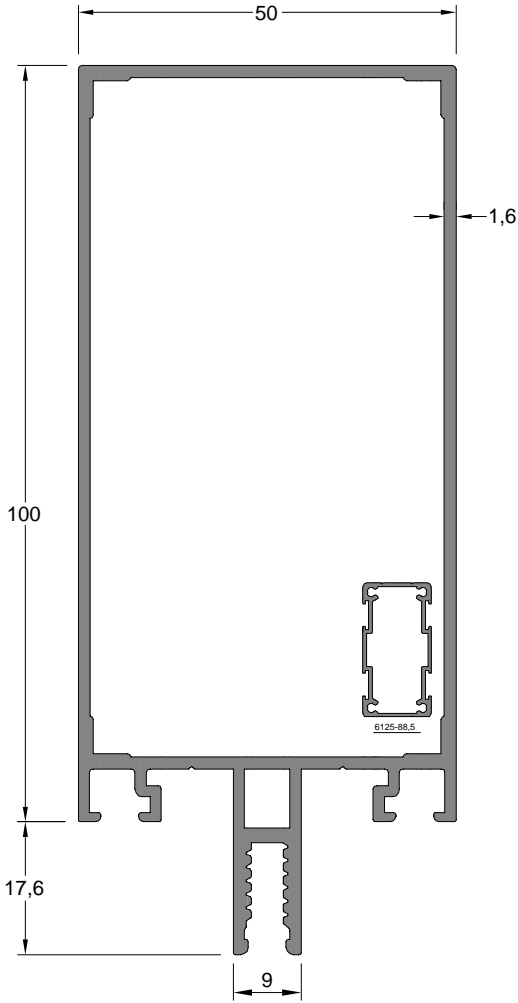
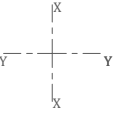

Dü ey Profili	Profil Kodu	(kg/mt)	Jx cm <sup>4</sup>	Jy cm <sup>4</sup>
VERTICAL PROFILE	Profile Code	Weight		
	6104	1,681	93,12	23,19

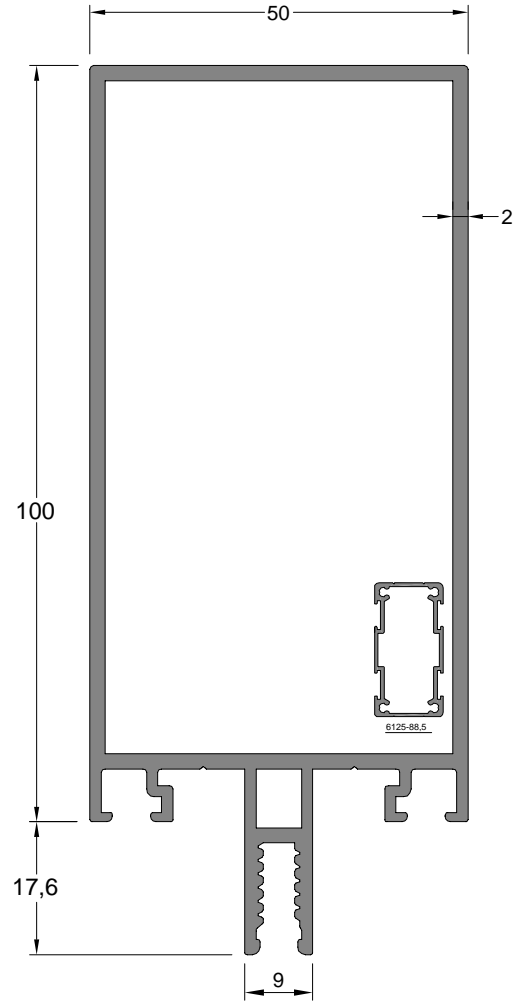

Dü ey Profili	Profil Kodu	(kg/mt)	Jx cm <sup>4</sup>	Jy cm <sup>4</sup>
VERTICAL PROFILE	Profile Code	Weight		
	6105	1,931	103,93	26,95

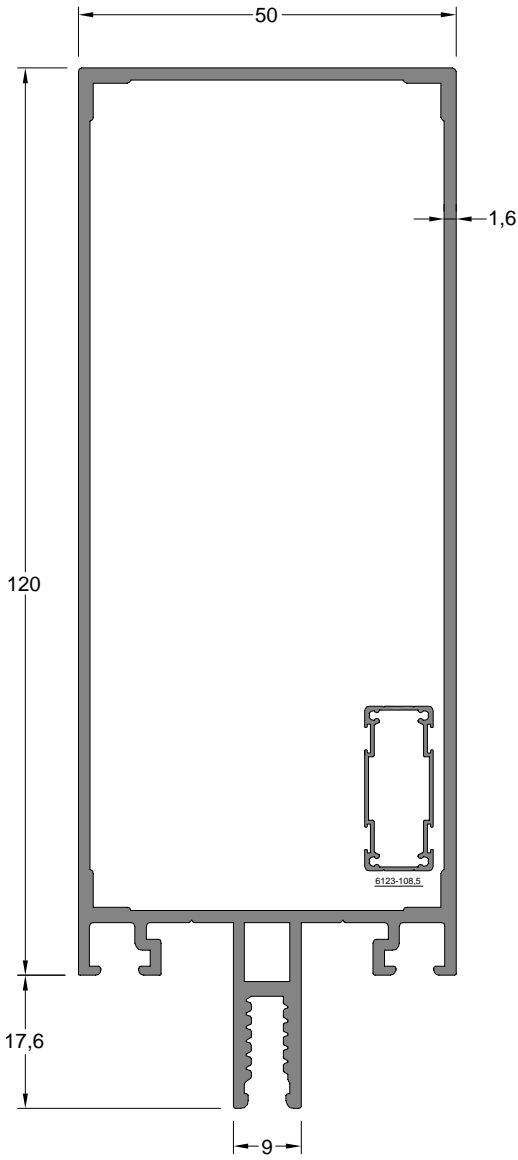
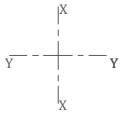

Dü ey Profili VERTICAL PROFILE	Profil Kodu Profile Code	(kg/mt) Weight	Jx cm <sup>4</sup>	Jy cm <sup>4</sup>
	6102	1,854	142,77	26,93

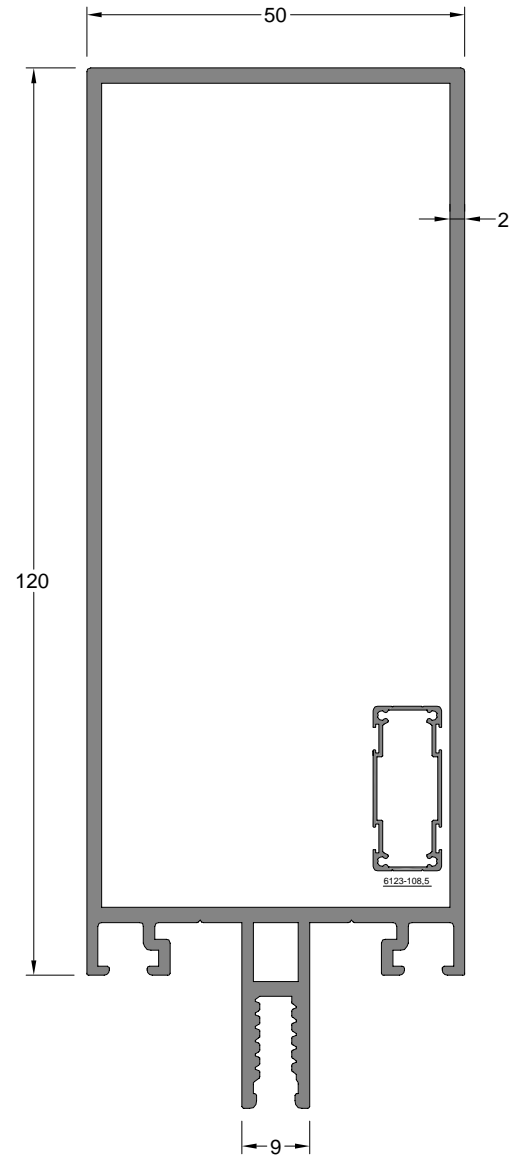

Dü ey Profili VERTICAL PROFILE	Profil Kodu Profile Code	(kg/mt) Weight	Jx cm <sup>4</sup>	Jy cm <sup>4</sup>
	6103	2,148	160,11	31,52

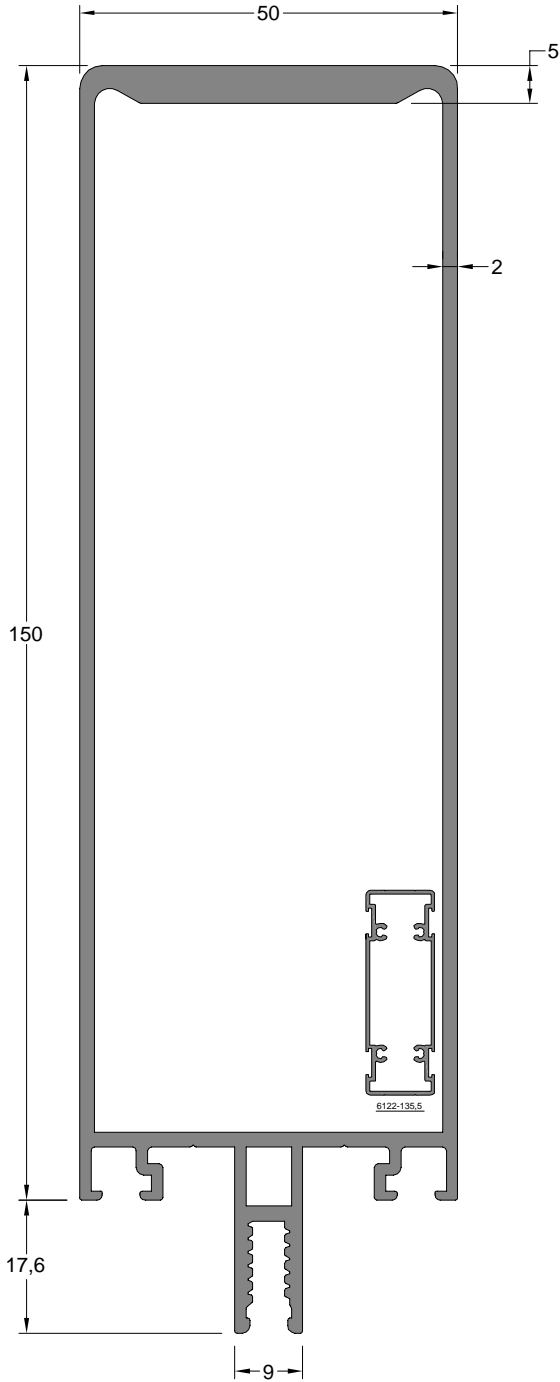
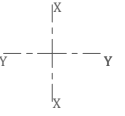

Dü ey Profili VERTICAL PROFILE	Profil Kodu Profile Code	(kg/mt) Weight	Jx cm <sup>4</sup>	Jy cm <sup>4</sup>
	6101	2,795	345,36	39,97

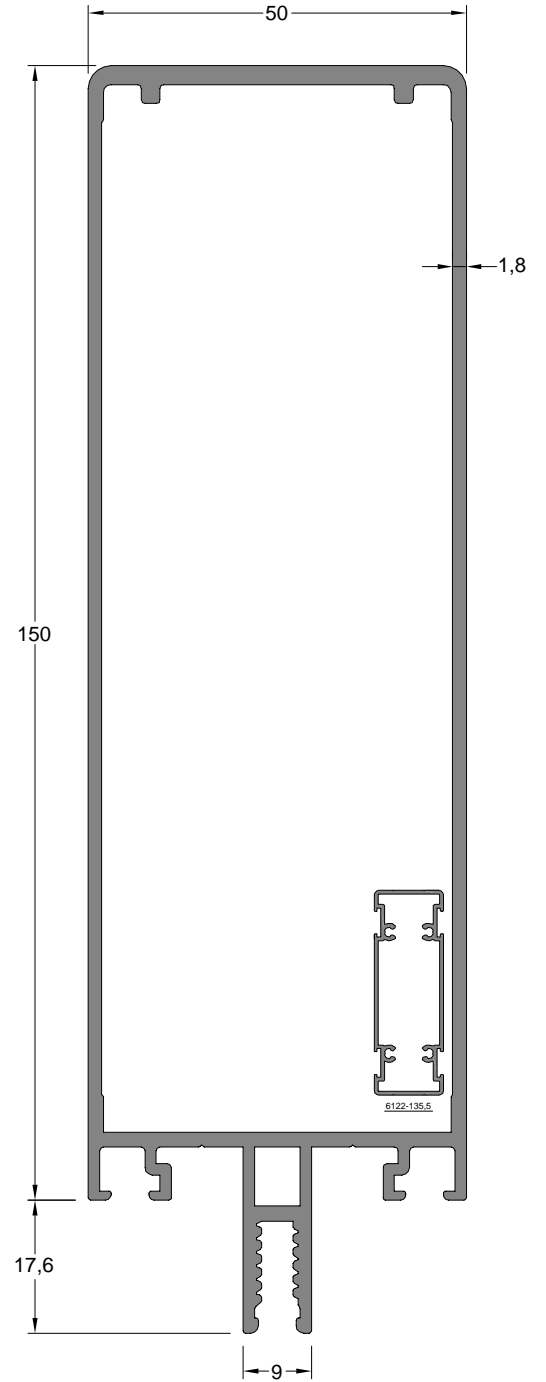

Dü ey Profili VERTICAL PROFILE	Profil Kodu Profile Code	(kg/mt) Weight	Jx cm <sup>4</sup>	Jy cm <sup>4</sup>
	6100	2,421	287,96	36,26

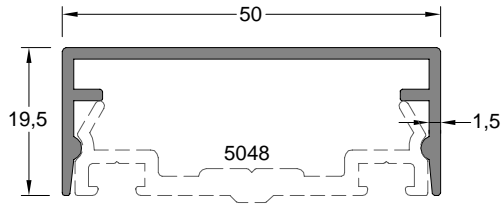
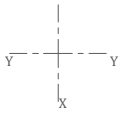

Kapak Profili COVER PROFILE	Profil Kodu Profile Code	(kg/mt) Weight
	2006	0,385

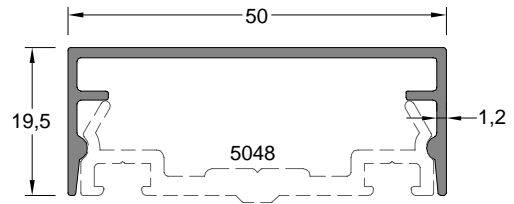

Kapak Profili COVER PROFILE	Profil Kodu Profile Code	(kg/mt) Weight
	5123	0,341

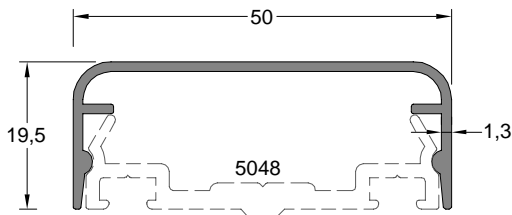

Kapak Profili COVER PROFILE	Profil Kodu Profile Code	(kg/mt) Weight
	5046	0,334

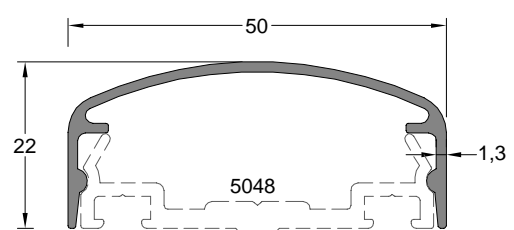

Kapak Profili COVER PROFILE	Profil Kodu Profile Code	(kg/mt) Weight
	2049	0,331

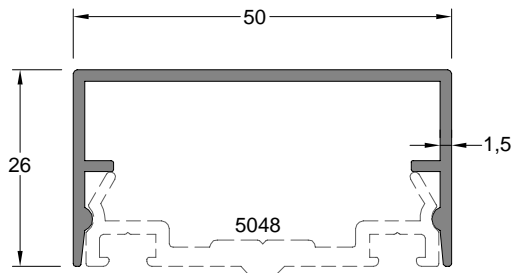

Kapak Profili COVER PROFILE	Profil Kodu Profile Code	(kg/mt) Weight
	2009	0,439

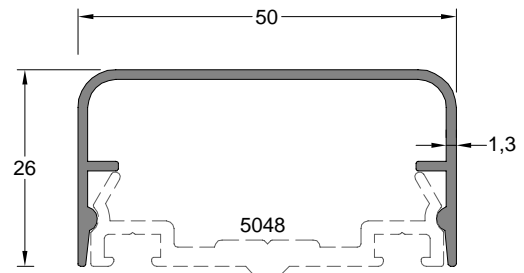

Kapak Profili COVER PROFILE	Profil Kodu Profile Code	(kg/mt) Weight
	5045	0,380

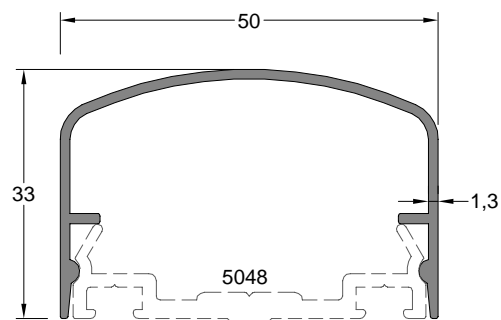

Kapak Profili COVER PROFILE	Profil Kodu Profile Code	(kg/mt) Weight
	2050	0,403

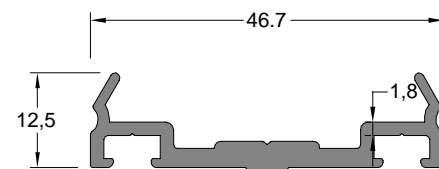

Kapak Altı Profili SUB-COVER PROFILE	Profil Kodu Profile Code	(kg/mt) Weight
	5048	0,466

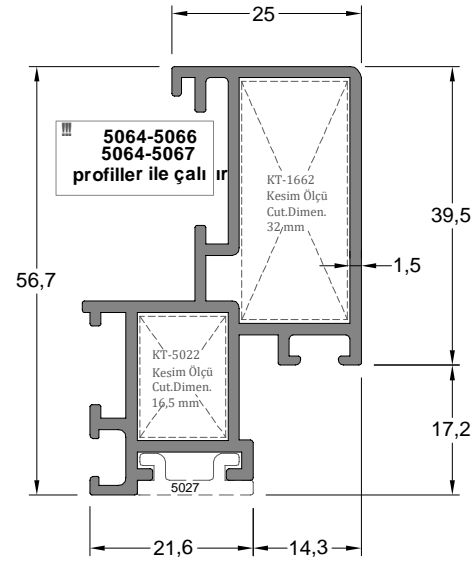
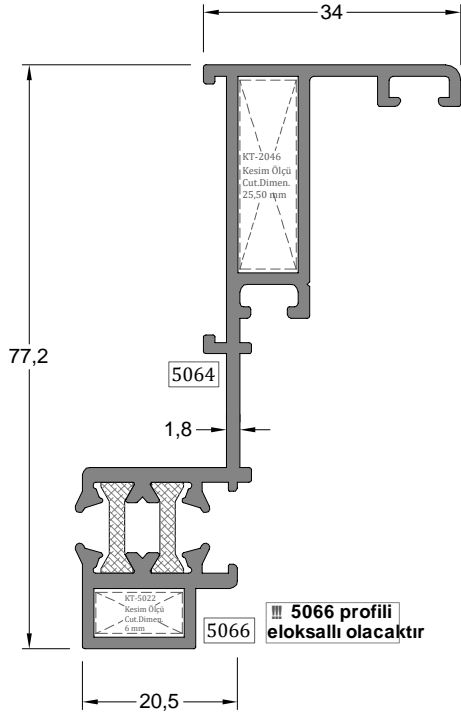
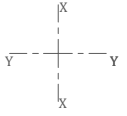

Kapaklı Cephe ç Kasa Profili	Profil Kodu Profile Code	(kg/mt) Weight	Jx cm <sup>4</sup>	Jy cm <sup>4</sup>
FRAME PROFILE	5064-5066	1,092	30,34	6,13

Kaset Profili	Profil Kodu Profile Code	(kg/mt) Weight	Jx cm <sup>4</sup>	Jy cm <sup>4</sup>
CASSETTE PROFILE	5062	0,918	10,08	3,91

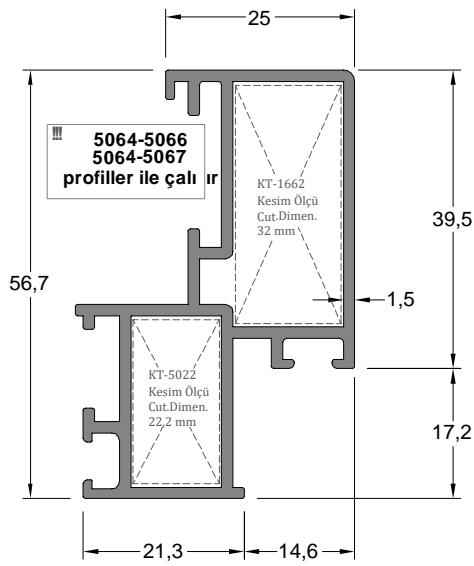

Kaset Profili	Profil Kodu Profile Code	(kg/mt) Weight	Jx cm <sup>4</sup>	Jy cm <sup>4</sup>
CASSETTE PROFILE	5081	0,908	10,46	3,87

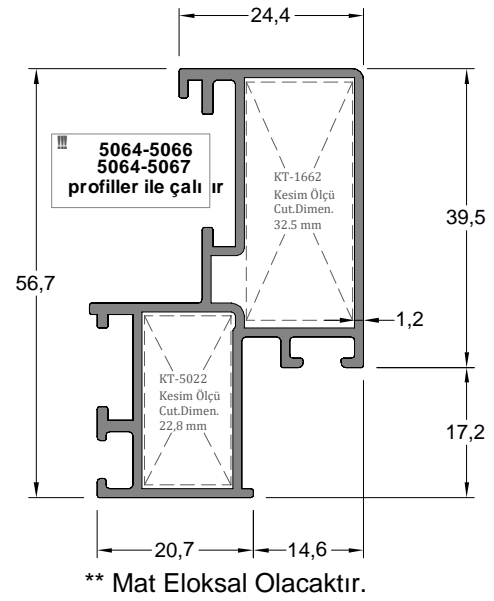

\*\* Mat Eloksal Olacaktır.

Kaset Profili	Profil Kodu Profile Code	(kg/mt) Weight	Jx cm <sup>4</sup>	Jy cm <sup>4</sup>
CASSETTE PROFILE	5093	0,760	8,86	3,21

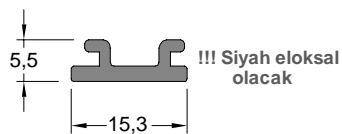

Cam Yapı tırma Profili	Profil Kodu Profile Code	(kg/mt) Weight
GLASS BONDING PROFILE	5027	0,128

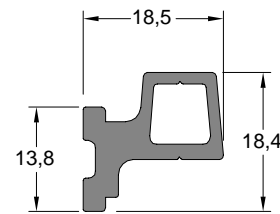

Kaset Profili	Profil Kodu Profile Code	(kg/mt) Weight
CASSETTE PROFILE	5094	0,340

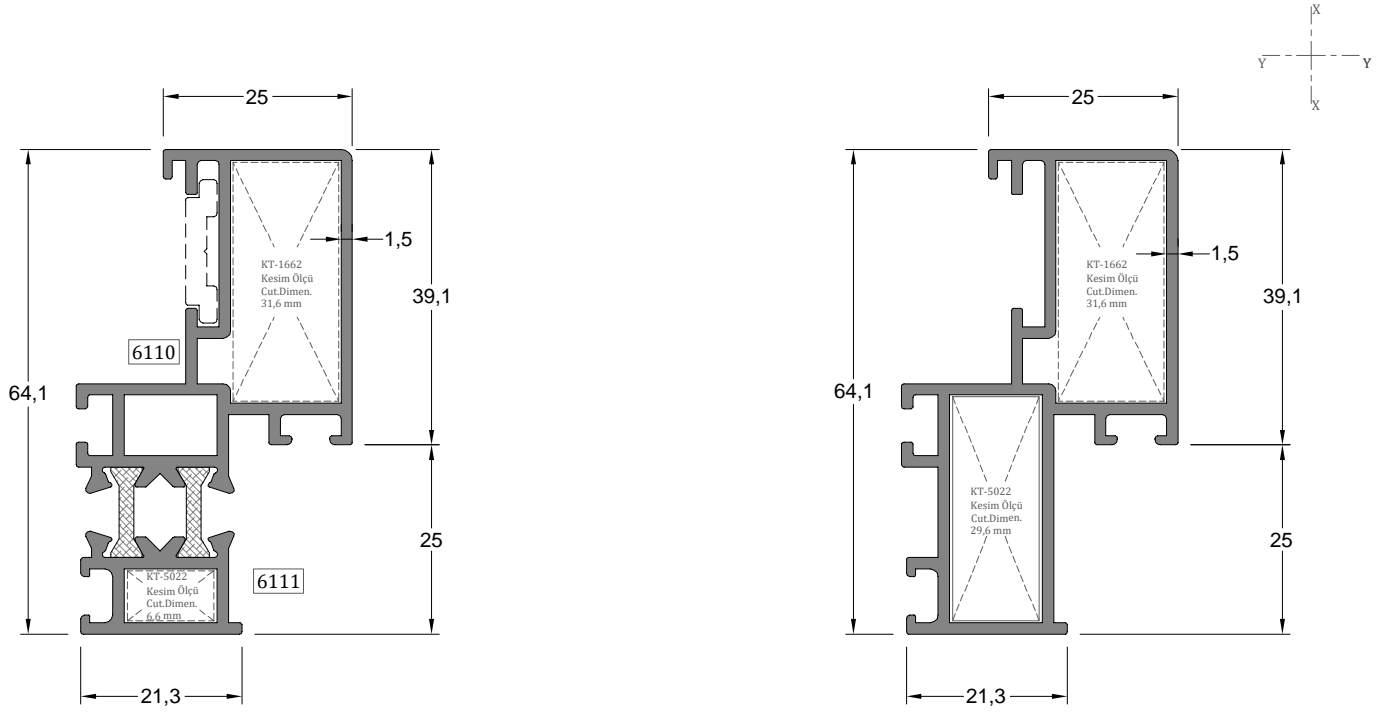

Gizli Kanat Profili HIDDEN SASH PROFILE	Profil Kodu Profile Code	(kg/mt) Weight	Jx cm <sup>4</sup>	Jy cm <sup>4</sup>
	6110-6111	1,224	16,89	3,18

Gizli Kanat Profili HIDDEN SASH PROFILE	Profil Kodu Profile Code	(kg/mt) Weight	Jx cm <sup>4</sup>	Jy cm <sup>4</sup>
	6112	0,985	15,20	3,06

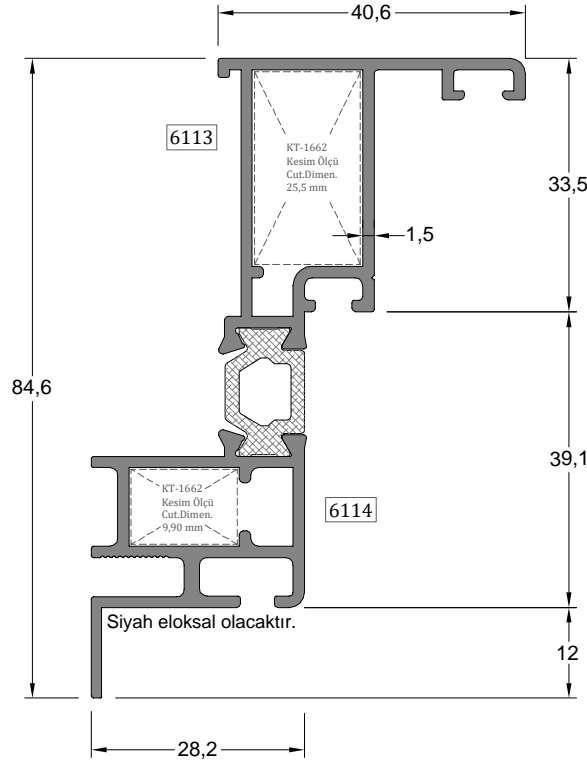

Gizli Kanat Profili HIDDEN SASH PROFILE	Profil Kodu Profile Code	(kg/mt) Weight	Jx cm <sup>4</sup>	Jy cm <sup>4</sup>
	6113-6114	1,317	34,72	3,43

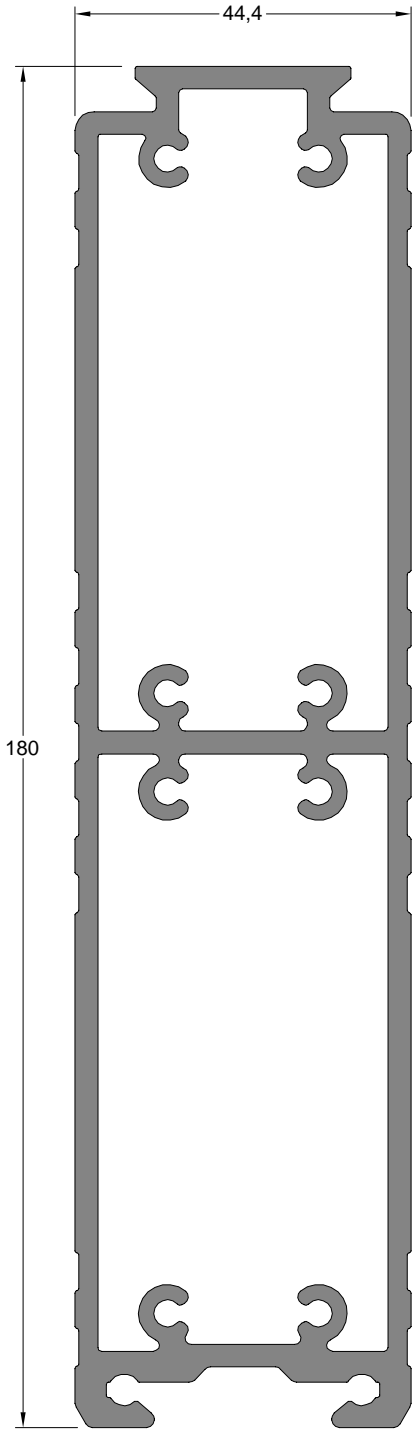
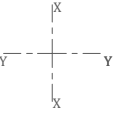

!!!! TM DŞEY PROFİLLERLE UYUMLU ÇALIŞIR

Dilatasyon Profili DILATATION PROFILE	Profil Kodu Profile Code	(kg/mt) Weight
	5129	4,655

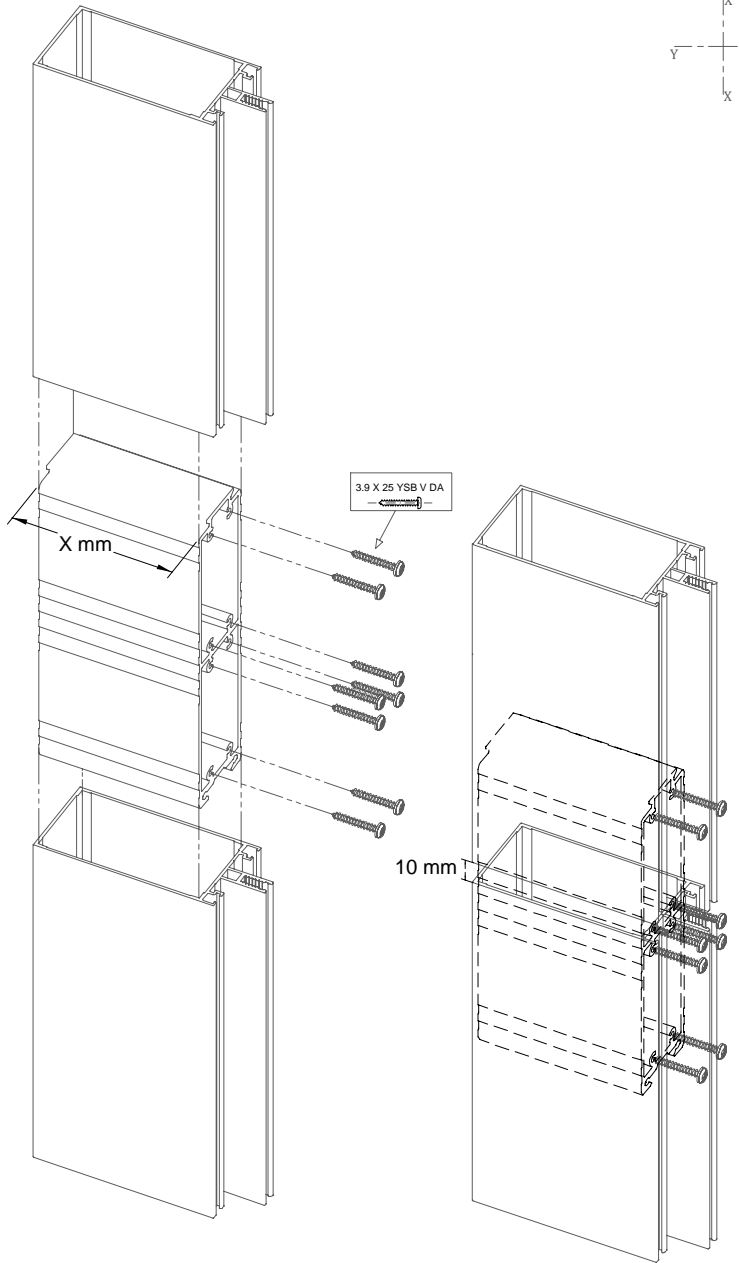

## DŞEY BAĖLANTI AKSESUARLARI

KULLANILDIĖI PROFİL	KESİM BOYU X (mm)
6100	135,5
6101	135,5
6102	108,5
6103	108,5
6104	88,5
6105	88,5
6106	68,5
6107	68,5
6108	48,5
6109	48,5



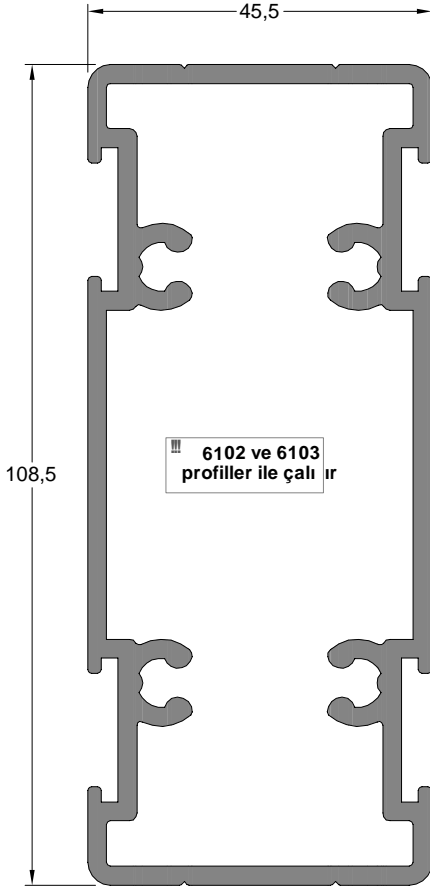

Dilatasyon Profili	Profil Kodu	(kg/mt)
DILATATION PROFILE	Profile Code	Weight
	6123	2,753

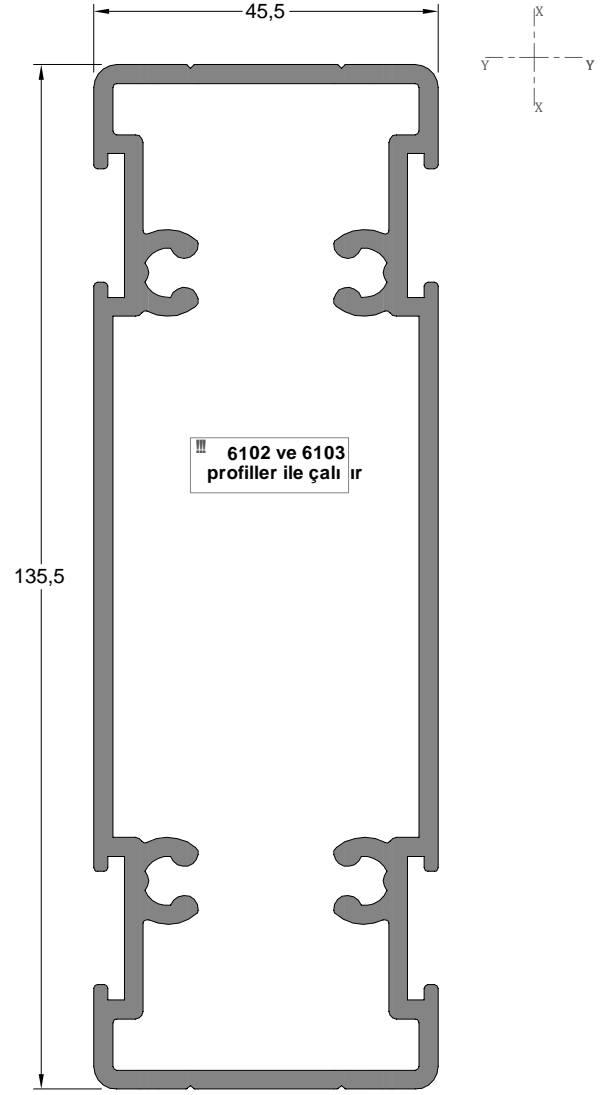

Dilatasyon Profili	Profil Kodu	(kg/mt)
DILATATION PROFILE	Profile Code	Weight
	6122	3,119

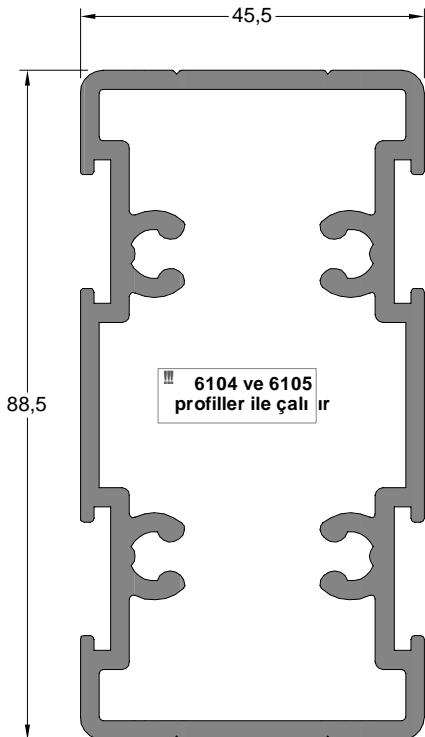

Dilatasyon Profili	Profil Kodu	(kg/mt)
DILATATION PROFILE	Profile Code	Weight
	6125	2,484

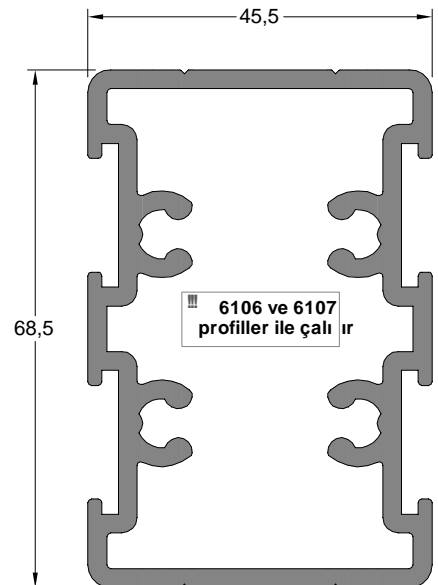

Dilatasyon Profili	Profil Kodu	(kg/mt)
DILATATION PROFILE	Profile Code	Weight
	6124	2,199

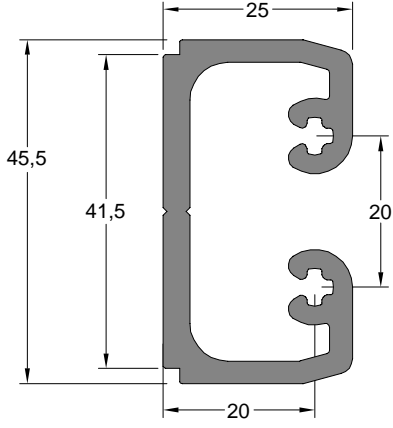

Ba lantı Profili CONNECTION PROFILE	Profil Kodu Profile Code	(kg/mt) Weight
	5042	1,144

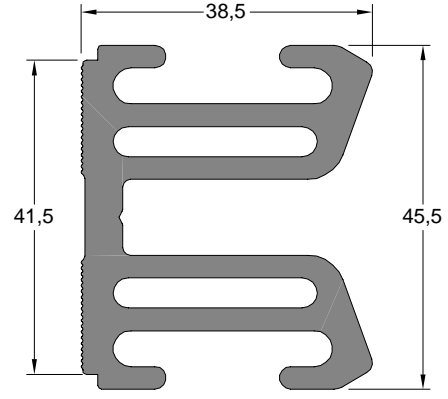

Ba lantı Profili CONNECTION PROFILE	Profil Kodu Profile Code	(kg/mt) Weight
	6121	2,027

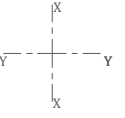

## YATAY BAĞLANTI AKSESUARLARI

BAĞLANTI PROFİL NO	KULLANILDIĞI PROFİL	KESİM BOYU X (mm)
6121	6100	135,5
	6101	135,5
	6102	108,5
	6103	108,5
5042	6104	88,5
	6105	88,5
	6106	68,5
	6107	68,5
	6108	48,5
	6109	48,5

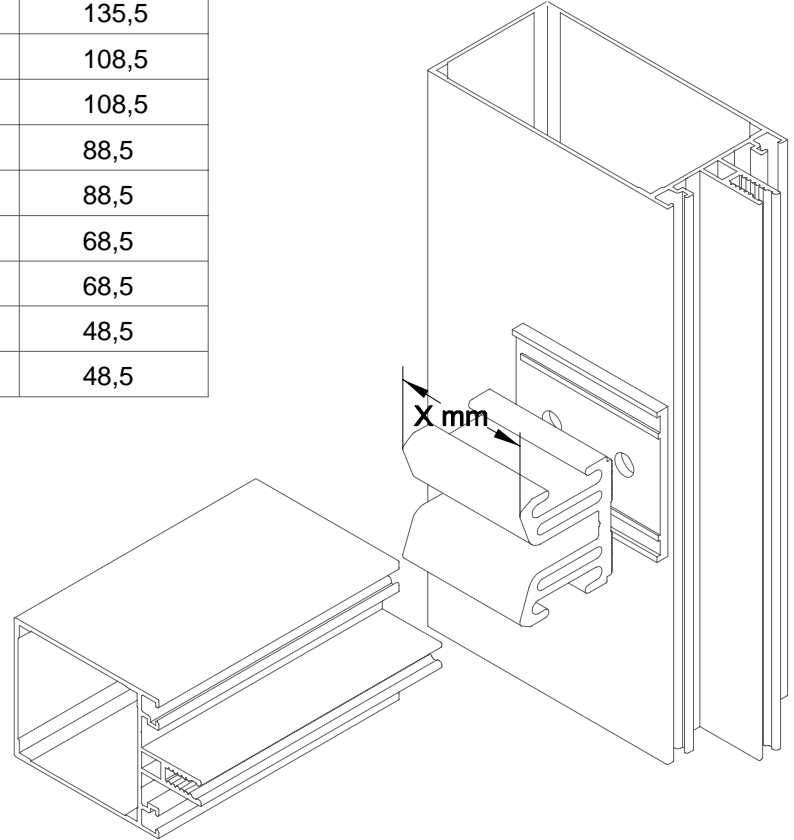

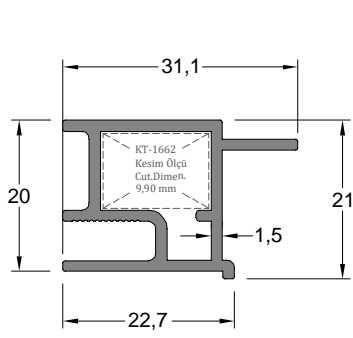

Tek Cam Kaset Profili	Profil Kodu	(kg/mt)
SINGLE GLASS CASSETTE PROFILE	Profile Code	Weight
	6115	0,411

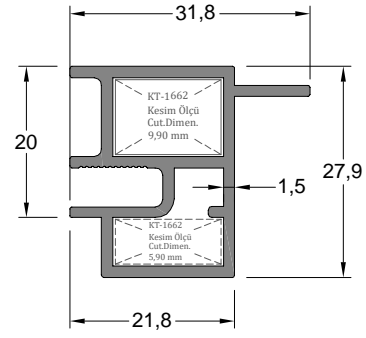

Tek Cam Kaset Profili	Profil Kodu	(kg/mt)
SINGLE GLASS CASSETTE PROFILE	Profile Code	Weight
	6116	0,530

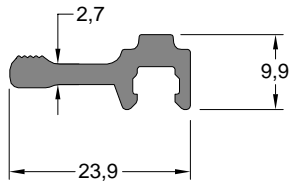
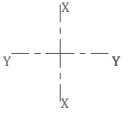

Cam Çita Klips Profili	Profil Kodu	(kg/mt)
GLASS BEAD CLIP PROFILE	Profile Code	Weight
	6118	0,262

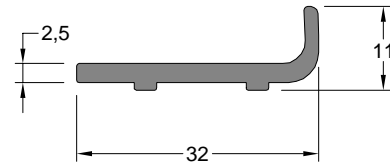

Cam Altı Takoz Profili	Profil Kodu	(kg/mt)
SUB-GLASS WEDGE PROFILE	Profile Code	Weight
	6120	0,265

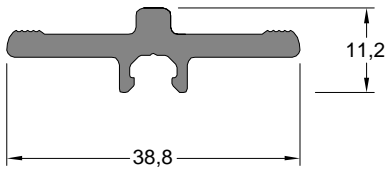

Cam Çita Klips Profili	Profil Kodu	(kg/mt)
GLASS BEAD CLIP PROFILE	Profile Code	Weight
	6119	0,407

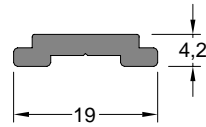

Tij Profili	Profil Kodu	(kg/mt)
STEM BAR PROFILE	Profile Code	Weight
	1122	0,157

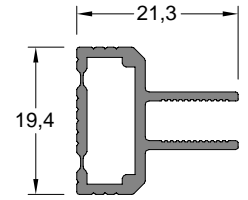

Cam Altı Takoz Profili	Profil Kodu	(kg/mt)
SUB-GLASS WEDGE PROFILE	Profile Code	Weight
	6117	0,250

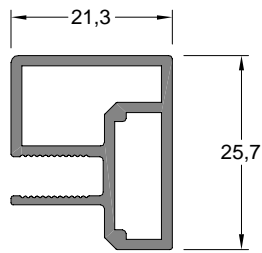

Cam Çita Klips Profili	Profil Kodu	(kg/mt)
GLASS BEAD CLIP PROFILE	Profile Code	Weight
	9748	0,419

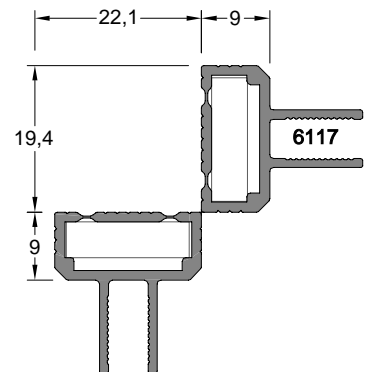
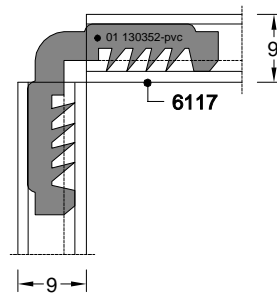

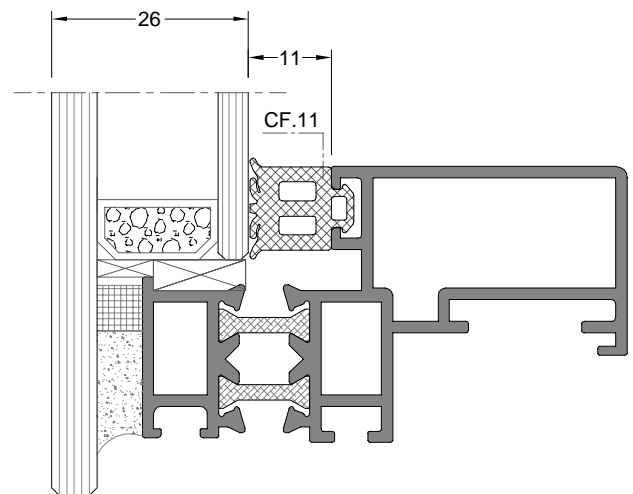
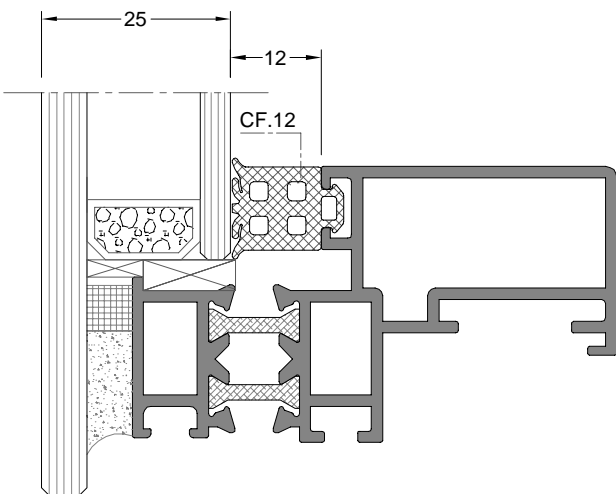
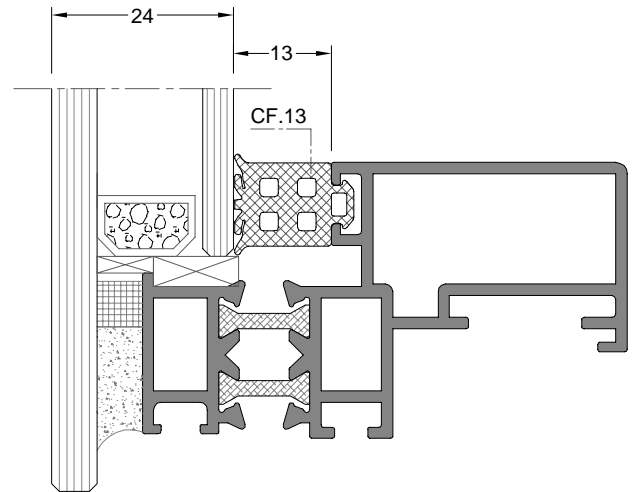
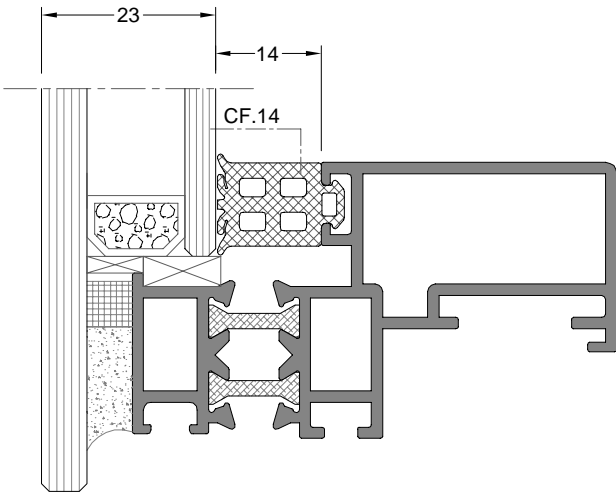
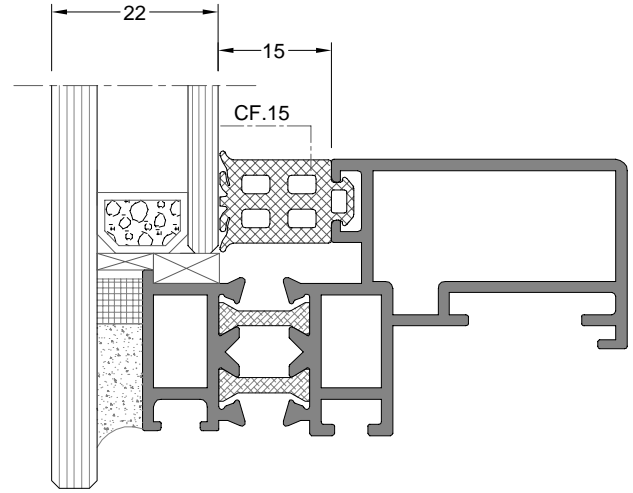
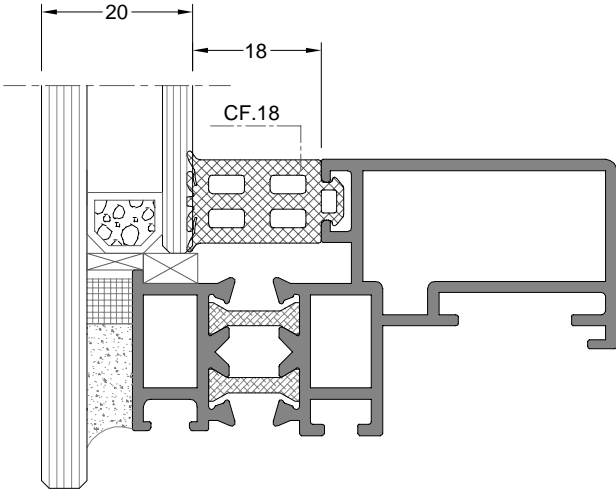
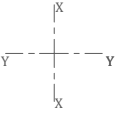

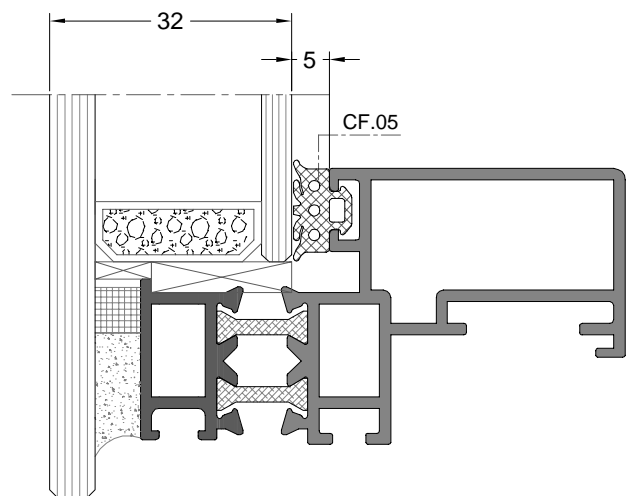
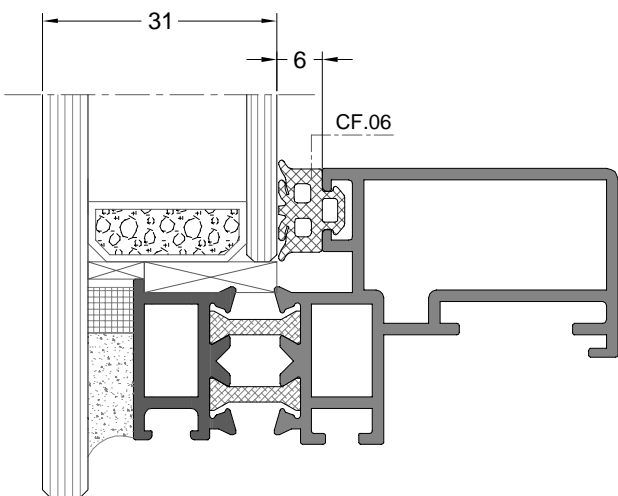
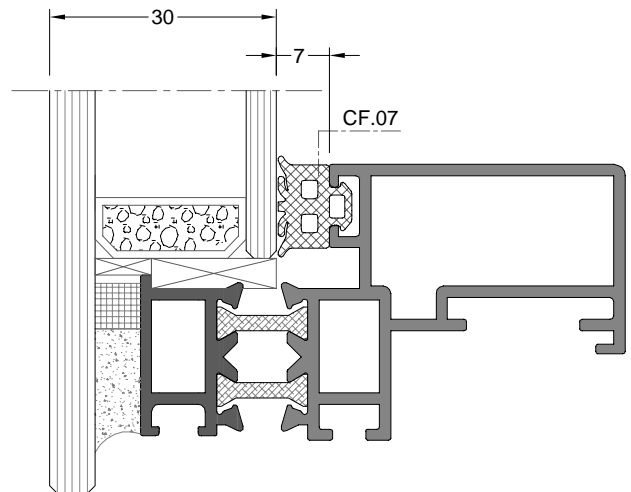
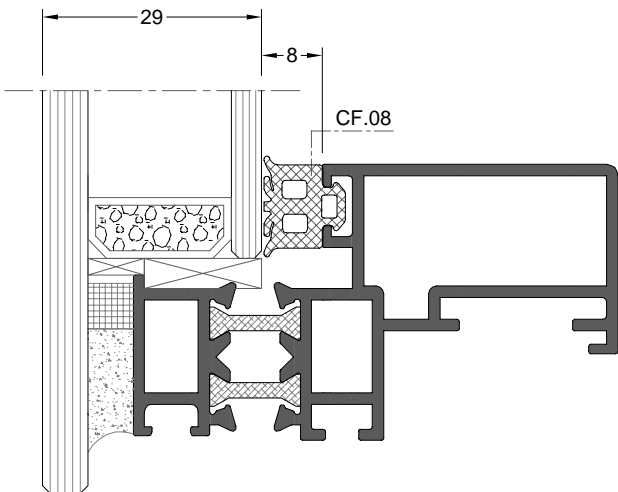
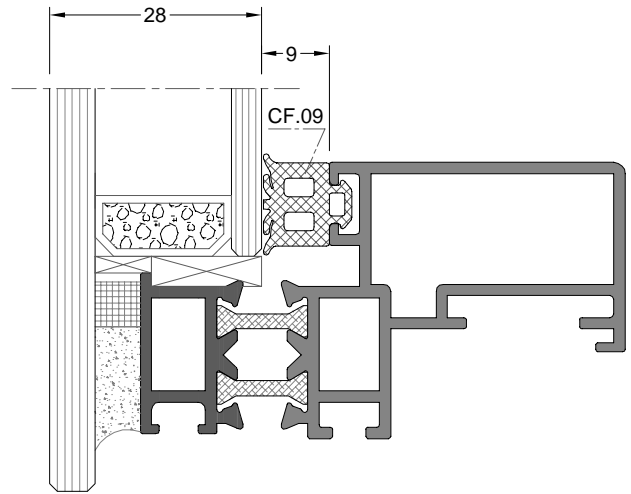
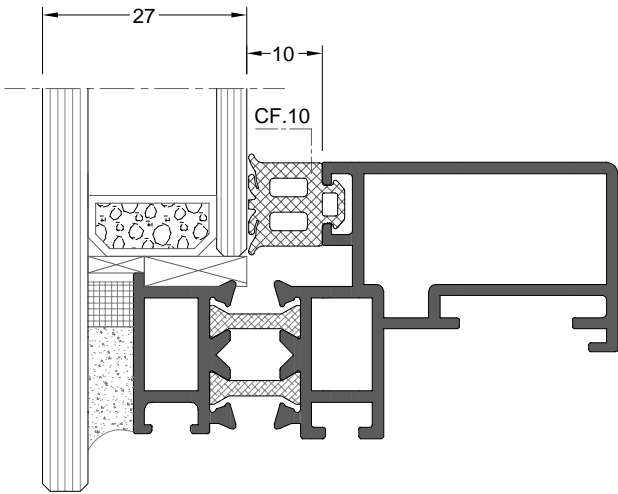
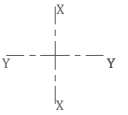

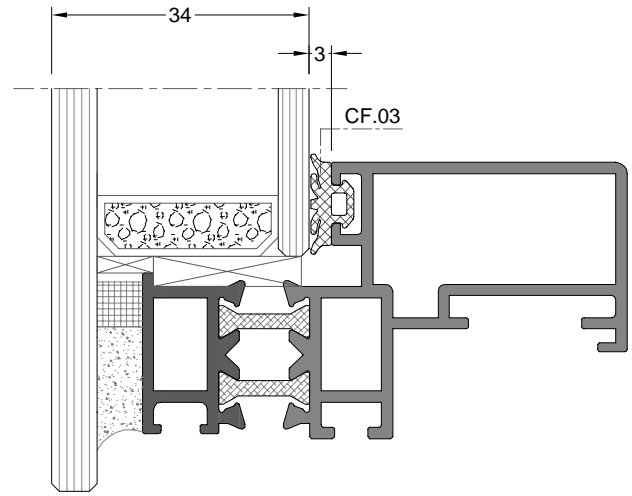
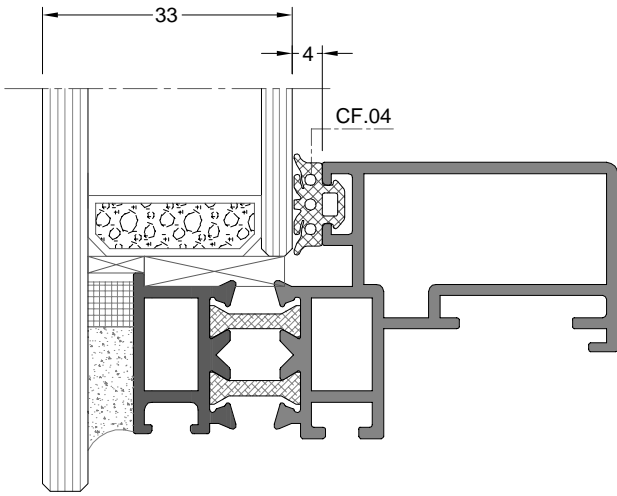
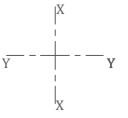

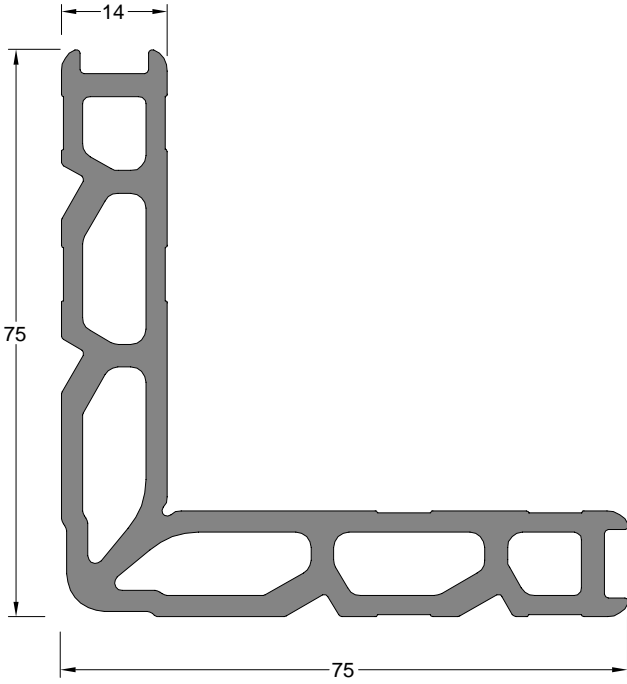
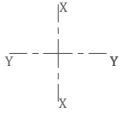

Kö e Takoz Profili CORNER WEDGE PROFILE	Profil Kodu Profile Code	(kg/mt) Weight
	1662	2,591

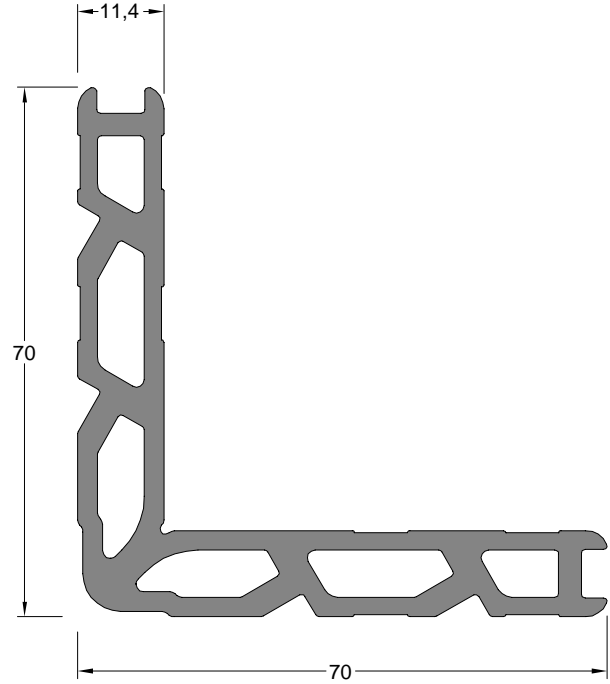

Kö e Takoz Profili CORNER WEDGE PROFILE	Profil Kodu Profile Code	(kg/mt) Weight
	5022	2,370

Kö e Takozu Profil Kodu Corner Wedge Profile Code	Kullanıldı ı Profil Profile Used	Kesim Boyu (mm) Cutting Length (mm)
1662	6110	31,60 mm
	6113	25,50 mm
	6114,6115,6116	9,90 mm
	6116	5,90 mm

Kö e Takozu Profil Kodu Corner Wedge Profile Code	Kullanıldı ı Profil Profile Used	Kesim Boyu (mm) Cutting Length (mm)
5022	6111	6,60 mm
	6112	29,60 mm

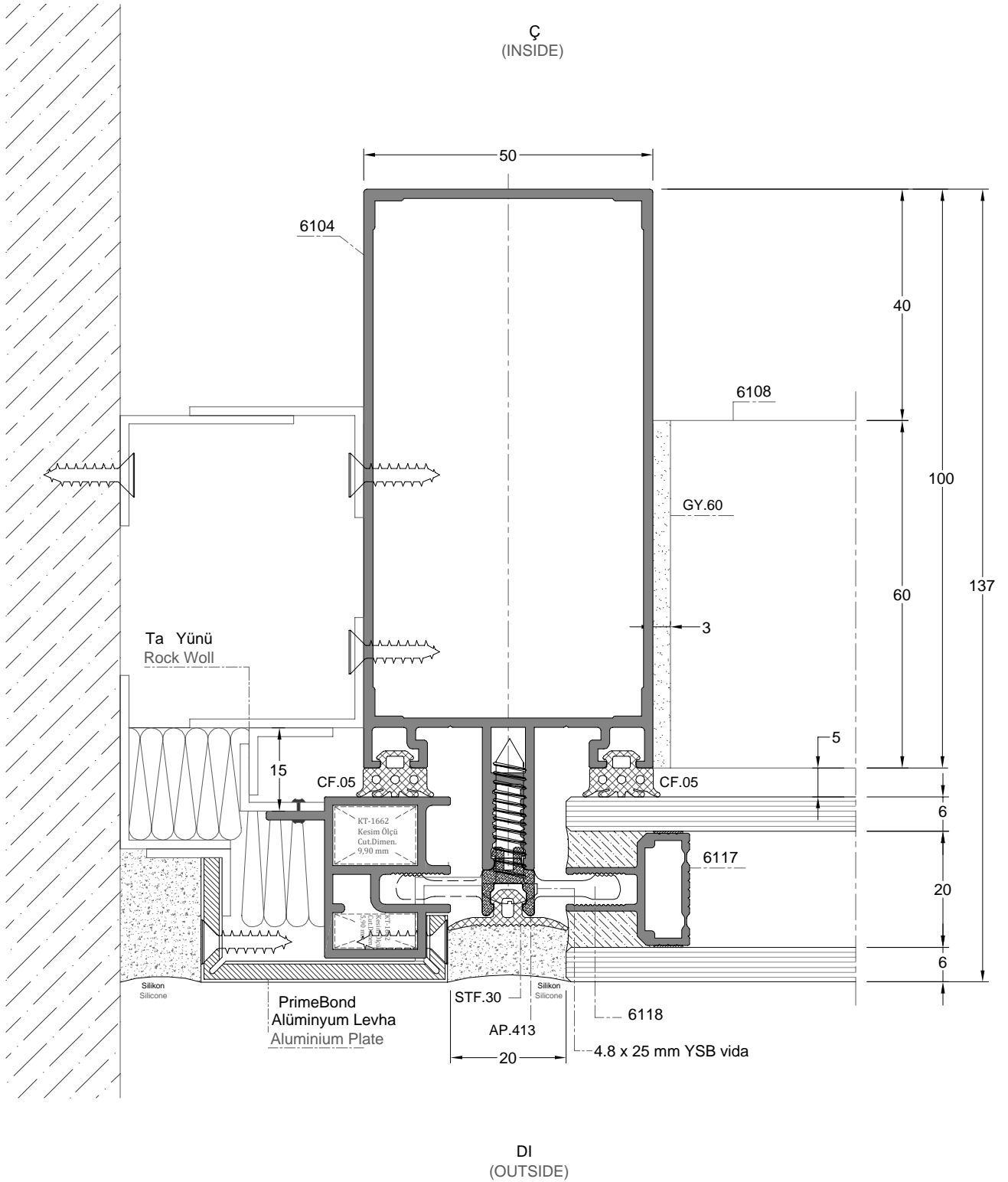
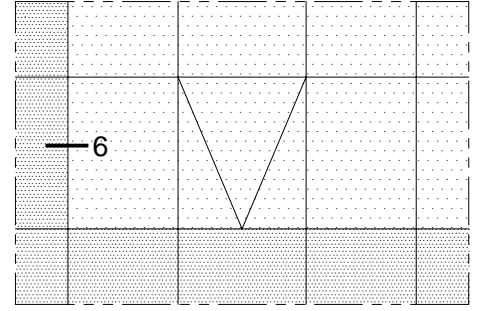



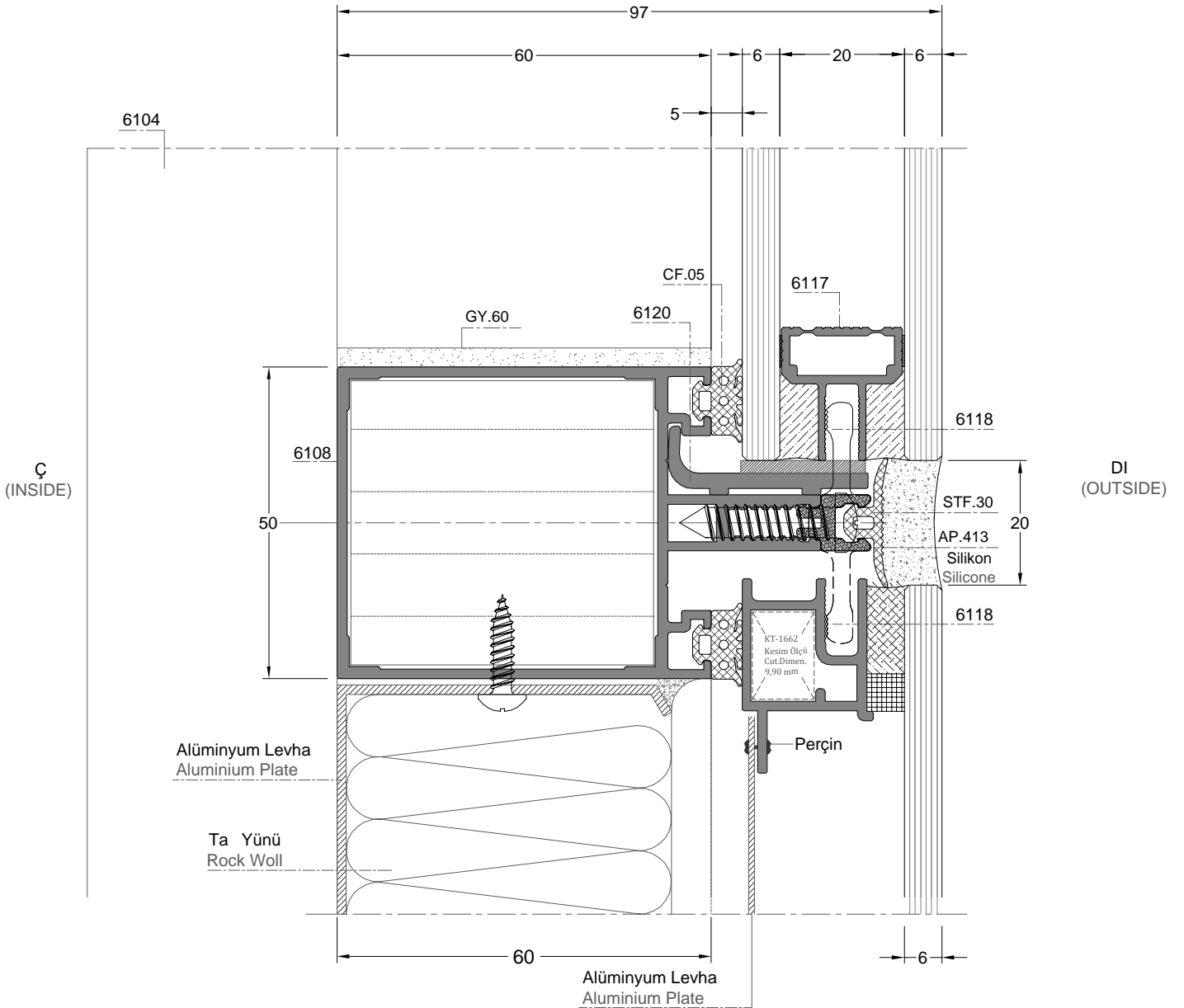
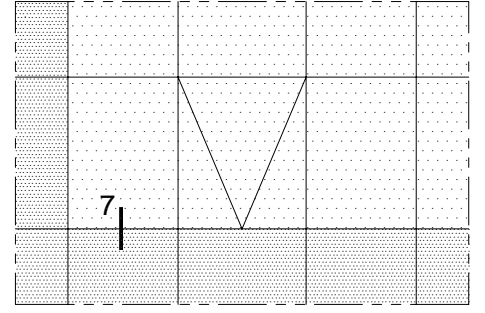

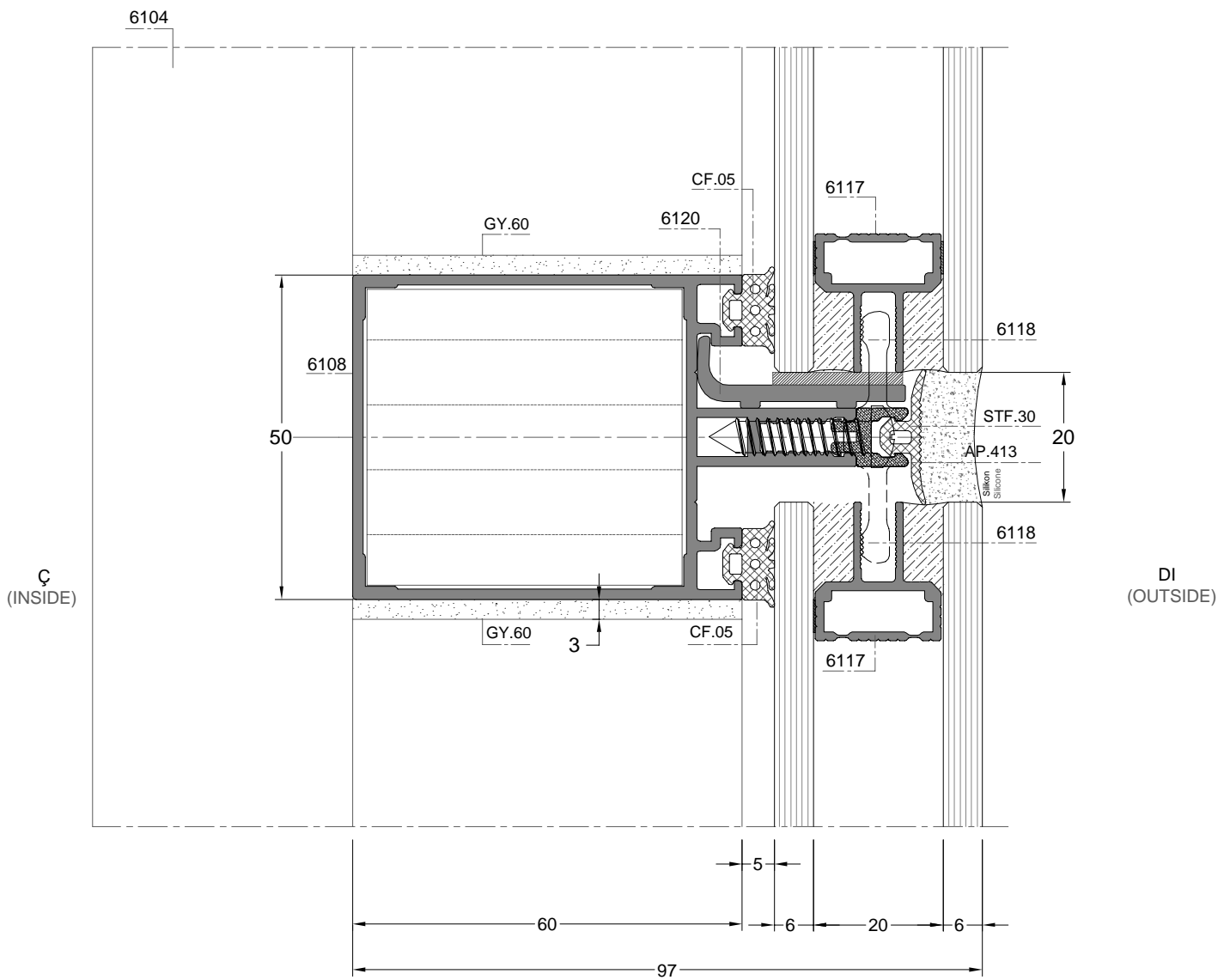
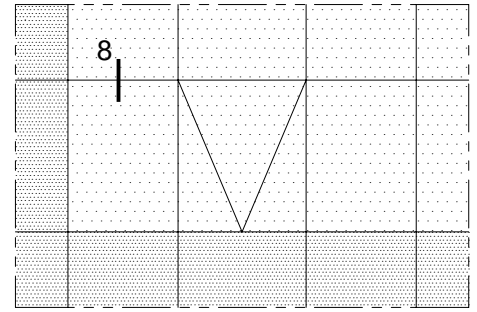

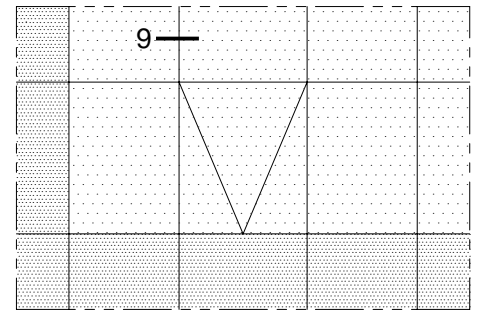

Ç  
(INSIDE)

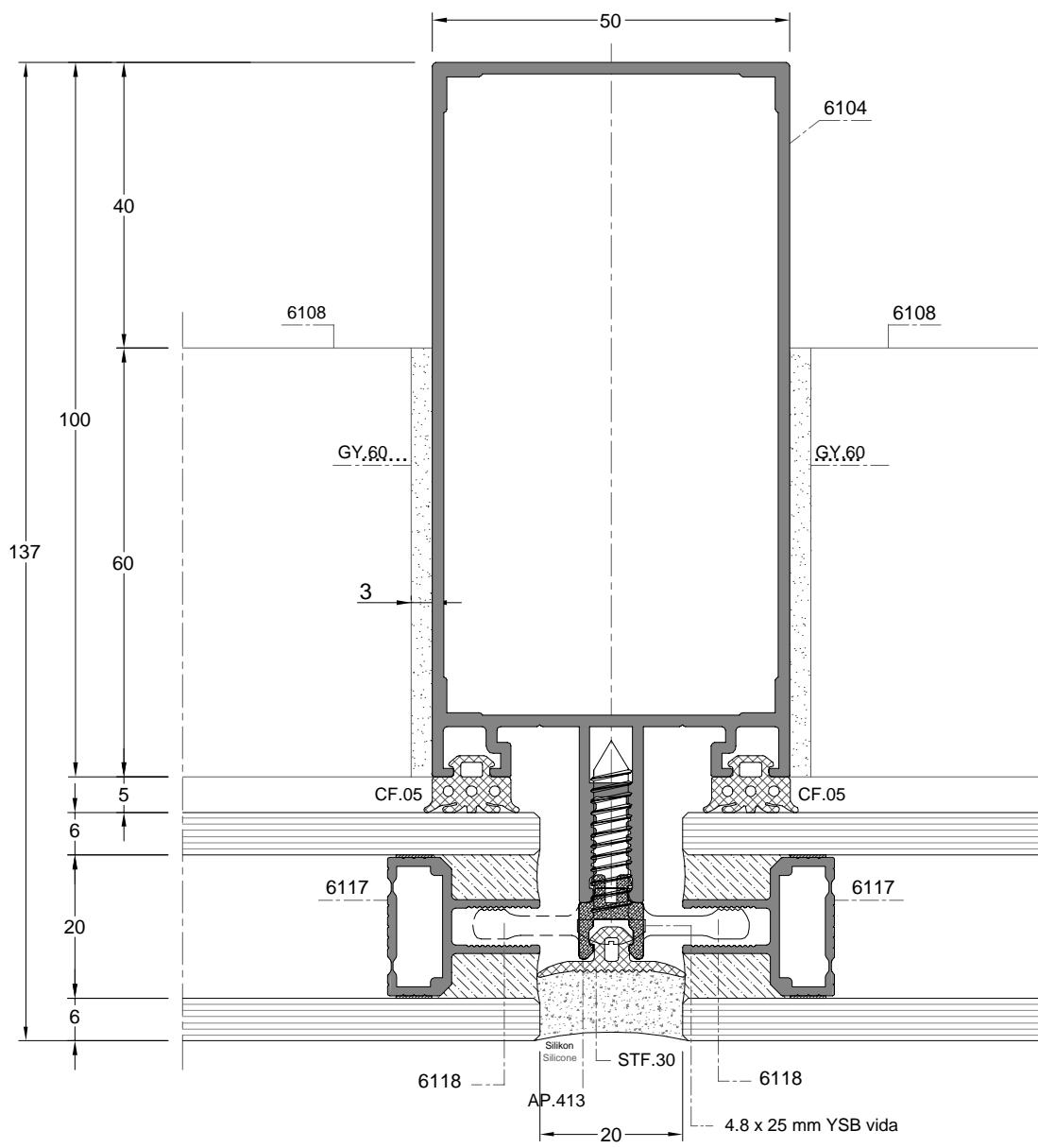

DI  
(OUTSIDE)

