

Dış Mekan Sistemi
Outdoor System

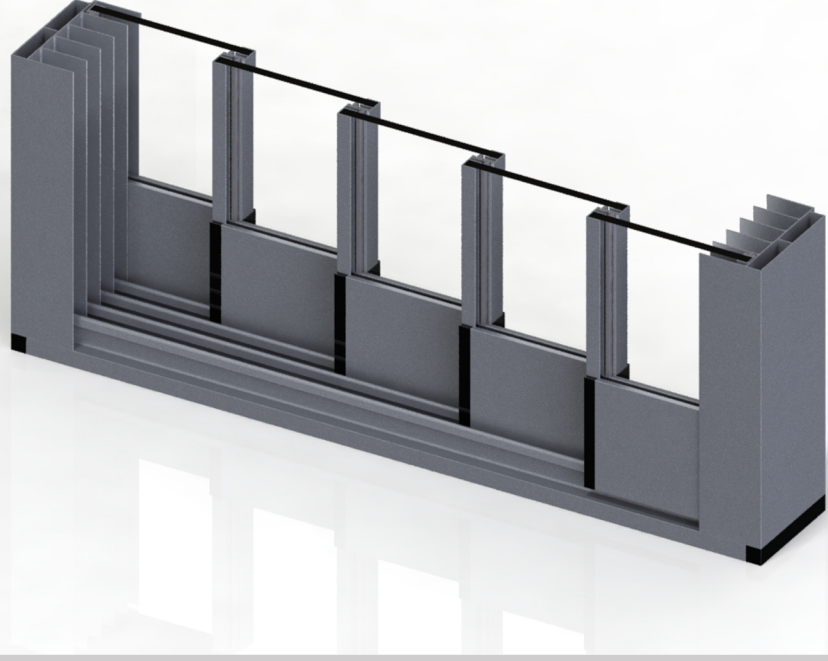

SCB100

Sürme Cam Balkon Sistemi
Sliding Balcony Glazing System

SCB100 Sürme Cam Balkon Sistemi

SCB100 Sliding Balcony Glazing System

TEKNİK ÖZELLİKLER / TECHNICAL PROPERTIES

SCB100



Kasa Geniřliđi / Frame Width	58-101 mm
Kanat Geniřliđi / Sash Width	17,5 mm
Profil Et Kalınlıđı / Profile Wall Thickness	1,4 - 1,7 mm
Cam Kalınlıđı / Glazing Thickness	8 - 10 mm
Maks. Kanat Geniřliđi / Max. Sash Width	1000 mm
Maks. Kanat Yüksekliđi / Max. Sash Height	3000 mm
Maks. Kanat Ađırlıđı / Max. Sash Weight	70 kg
Maks. Kanat Sayısı / Max. Sash Number	5 sol , 5 sađ

UYGULAMA SEÇENEKLERİ / APPLICATION OPTIONS

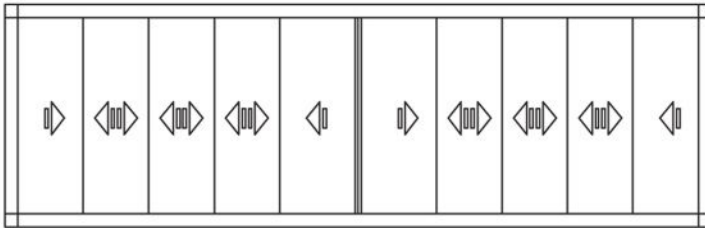
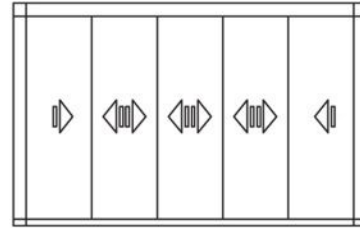
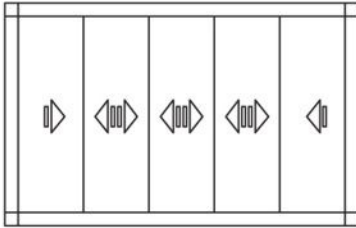
- 3 Raylı Eşikli-Eşiksiz / 3 Railed With Threshold - Without Threshold
- 5 Raylı Eşikli-Eşiksiz / 5 Railed With Threshold - Without Threshold
- U tipi Balkon / U Type Balcony
- L tipi Balkon / L Type Balcony
- 4 Raylı Eşikli / 4 Railed With Threshold
- 4+4 Kanat Birleřimi / 4+4 Sash Combination



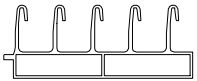
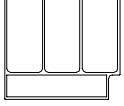
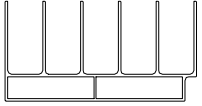
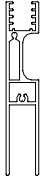
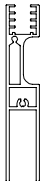
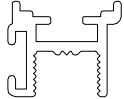
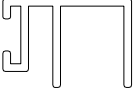

ALÜMİNYUM SANAYİ VE TİC. A.Ş.

PROF L KES T PROFILE SECTION	PROF L KODU PROFILE CODE	PROF L ADI PROFILE NAME	A IRLIK (kg/m) WEIGHT
	12016	3 RAYLI EŞİKSİZ ALT RAY PROFİLİ BOTTOM TRIPLE RAIL PROFILE (NON-THRESHOLD)	0,352 kg/mt
	9678	5 RAYLI EŞİKSİZ ALT RAY PROFİLİ BOTTOM QUINTUPLE RAIL PROFILE (NON-THRESHOLD)	0,759 kg/mt
	12015	3 RAYLI EŞİKLİ ALT RAY PROFİLİ BOTTOM TRIPLE RAIL PROFILE (THRESHOLD)	0,715 kg/mt
	5425	5 RAYLI EŞİKLİ ALT RAY PROFİLİ BOTTOM QUINTUPLE RAIL PROFILE (THRESHOLD)	1,737 kg/mt
	12014	3 RAYLI ÜST-YAN KASA PROFİLİ TOP-SIDE TRIPLE FRAME PROFILE	1,032 kg/mt
	5430	5 RAYLI ÜST-YAN KASA PROFİLİ TOP-SIDE QUINTUPLE FRAME PROFILE	1,533 kg/mt
	12018	ALT KANAT PROFİLİ (10 MM) BOTTOM SASH PROFILE (10 MM)	1,165 kg/mt
	12017	ALT KANAT PROFİLİ (8 MM) BOTTOM SASH PROFILE (8 MM)	1,189 kg/mt
	5429	ÜST KANAT PROFİLİ 8 MM TOP SASH PROFILE (8 MM)	0,156 kg/mt
	6198	YAN KANAT PROFİLİ (8 MM) SIDE SASH PROFILE (8 MM)	0,143 kg/mt

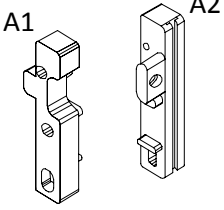
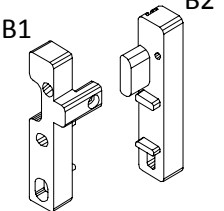
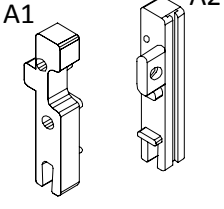
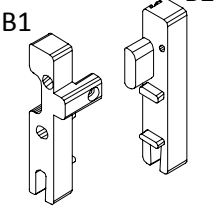
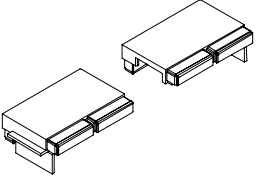
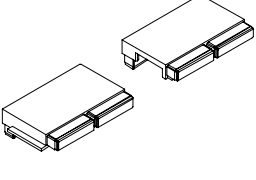
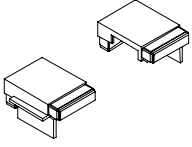
PROF L KES T PROFILE SECTION	PROF L KODU PROFILE CODE	PROF L ADI PROFILE NAME	A IRLİK (kg/m) WEIGHT
	7187	SON KANAT PROFİLİ (8 MM) LAST SASH PROFILE (8 MM)	0,098 kg/mt
	7191	SON KANAT PROFİLİ (10 MM) LAST SASH PROFILE (10 MM)	0,103 kg/mt
	9676	KULP PROFİLİ (10 MM) HANDLE PROFILE (10 MM)	0,640 kg/mt
	6196	ÜST KANAT PROFİLİ (10 MM) TOP SASH PROFILE (10 MM)	0,143 kg/mt
	6199	YAN KANAT PROFİLİ (10 MM) SIDE SASH PROFILE (10 MM)	0,134 kg/mt
	7326	CAM H PROFİLİ (8 MM) GLASS H PROFILE (8 MM)	0,169 kg/mt
	8766	CAM H PROFİLİ (10 MM) GLASS H PROFILE (10 MM)	0,196 kg/mt

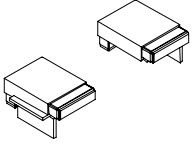
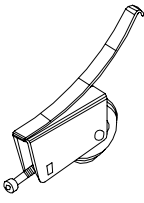
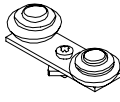
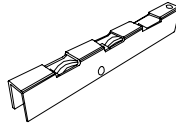
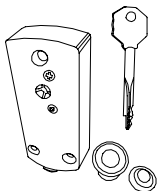
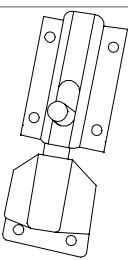
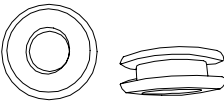
AKSESUAR ACCESSORY	STOK KODU REFERENCE CODE	AKSESUAR ADI DESCRIPTION	AKSESUAR KODU PRODUCT CODE	PAKET PACK
	13 500102	EŞİKSİZ / ALT KANAT KAPAĞI SOLA AÇILIR BOTTOM SASH COVER (NON-THRESHOLD / LEFT)	SCB100-İZ.A1	400 Tk / paket
	13 500103	EŞİKSİZ / ALT KANAT KAPAĞI SAĞA AÇILIR BOTTOM SASH COVER (NON-THRESHOLD / RIGHT)	SCB100-İZ.B1	400 Tk / paket
	13 500104	EŞİKLİ / ALT KANAT KAPAĞI SOLA AÇILIR BOTTOM SASH COVER (THRESHOLD / LEFT)	SCB100-Lİ.A1	400 Tk / paket
	13 500105	EŞİKLİ / ALT KANAT KAPAĞI SAĞA AÇILIR BOTTOM SASH COVER (THRESHOLD / RIGHT)	SCB100-Lİ.B1	400 Tk / paket
	13 500111	5 RAYLI ALT KASA KÖŞE TAKOZU QUINTUPLE RAIL CORNER JOINT (BOTTOM)	SCB100-5K.01	100 Tk / paket
	13 500112	5 RAYLI ÜST KASA KÖŞE TAKOZU QUINTUPLE RAIL CORNER JOINT (TOP)	SCB100-5K.02	100 Tk / paket
	13 500107	3 RAYLI ALT KASA KÖŞE TAKOZU TRIPLE RAIL CORNER JOINT (BOTTOM)	SCB100-3K.01	100 Tk / paket

AKSESUAR ACCESSORY	STOK KODU REFERENCE CODE	AKSESUAR ADI DESCRIPTION	AKSESUAR KODU PRODUCT CODE	PAKET PACK
	13 500108	3 RAYLI ÜST KASA KÖŞE TAKOZU TRIPLE RAIL CORNER JOINT (TOP)	SCB100-3K.02	100 Tk / paket
	13 500100	EŞİKSİZ KASA TEKLİ ALT RULMAN BOTTOM SINGLE ROLLER (NON-THRESHOLD)	SCB100-İZ.10	100 ad / paket
	13 500101	ÜST RULMAN TOP ROLLER	SCB100-ÜR.01	100 ad / paket
	13 500109	EŞİKLİ KASA ALT RULMAN BOTTOM ROLLER (THRESHOLD)	SCB100-Lİ.10	100 ad / paket
	05 030100	EŞİKSİZ SİSTEM KİLİT SLIDING LOCK (NON-THRESHOLD)	SCB100-İZ.20	2 ad / paket
	13 500125	EŞİKLİ FİŞEK SÜRGÜ KİLİT THRESHOLD TOWER BOLT	SCB100-Lİ.20	1 ad / paket
	13 500120	SÜRME KOL WEATHER STRIP	SCB100-SK.01	10 ad / paket
	03 050712	FİRÇA FİTİL WEATHER STRIP	SCB100-FÇ.712	200 mt / paket

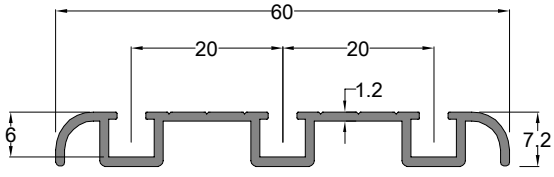

3 Raylı Eşiksiz Alt Ray Profili	Profil Kodu Profile Code	(kg/mt) Weight
BOTTOM TRIPLE RAIL PROFILE (NON-THRESHOLD)	12016	0,352

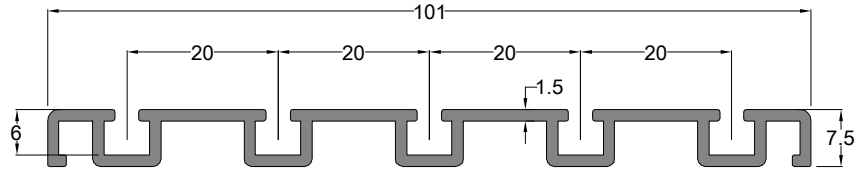

5 Raylı Eşiksiz Alt Ray Profili	Profil Kodu Profile Code	(kg/mt) Weight
BOTTOM QUINTUPLE RAIL PROFILE (NON-THRESHOLD)	9678	0,759

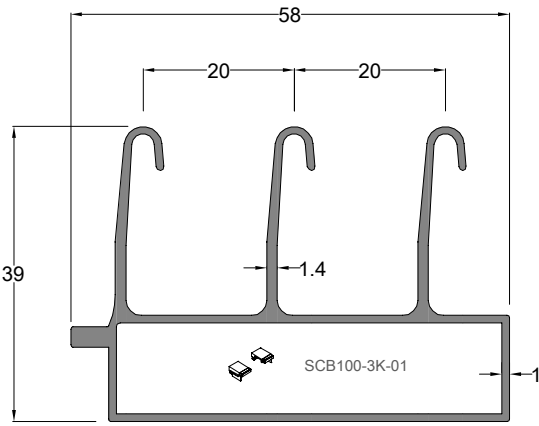

3 Raylı Eşikli Alt Ray Profili	Profil Kodu Profile Code	(kg/mt) Weight
BOTTOM TRIPLE RAIL PROFILE (THRESHOLD)	12015	0,715

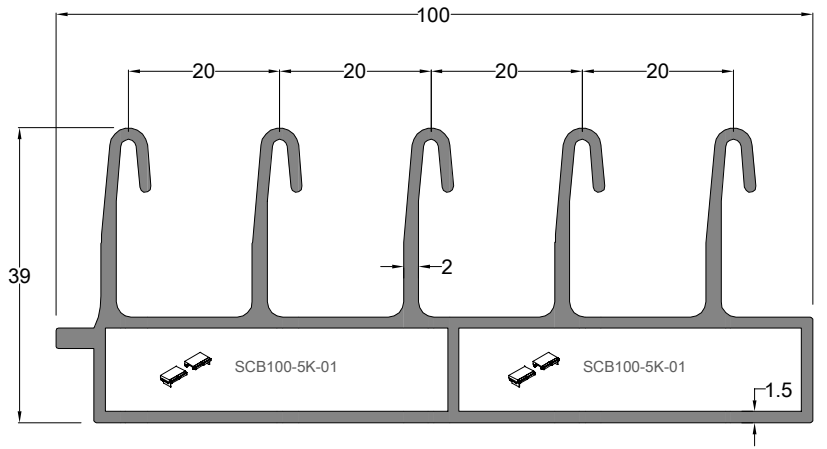

5 Raylı Eşikli Alt Ray Profili	Profil Kodu Profile Code	(kg/mt) Weight
BOTTOM QUINTUPLE RAIL PROFILE (THRESHOLD)	5425	1,737

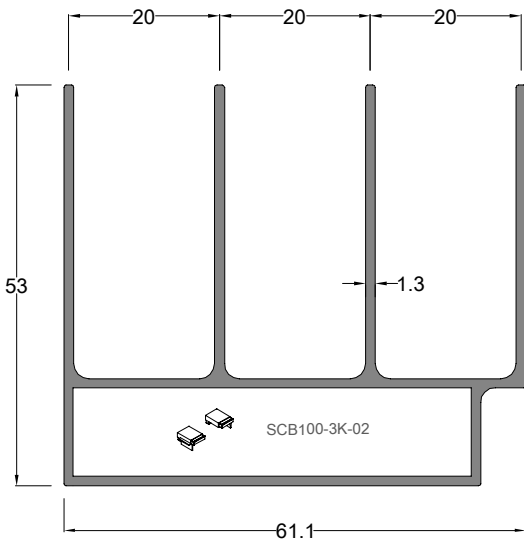

3 Raylı Üst-Yan Kasa Profili	Profil Kodu Profile Code	(kg/mt) Weight
TOP-SIDE TRIPLE FRAME PROFILE	12014	1,032

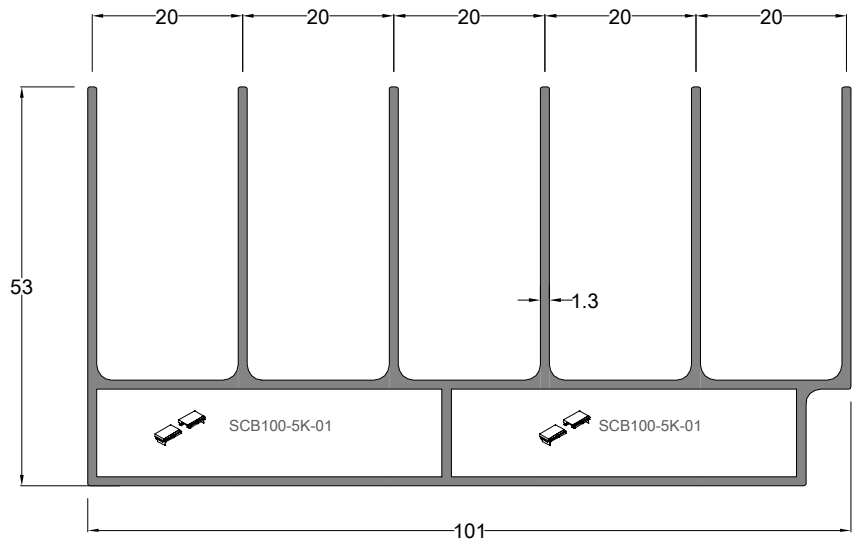

5 Raylı Üst-Yan Kasa Profili	Profil Kodu Profile Code	(kg/mt) Weight
TOP-SIDE QUINTUPLE FRAME PROFILE	5430	1,533

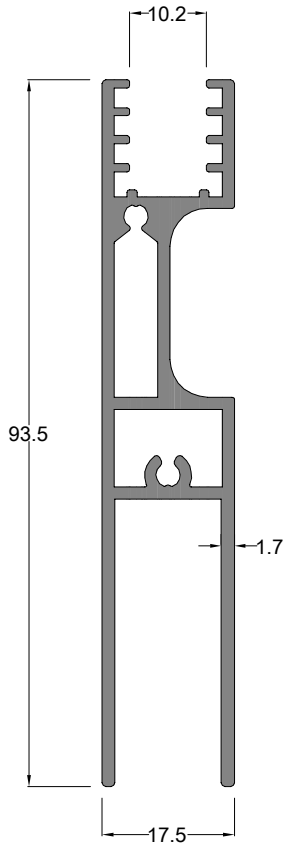

Alt Kanat 10 mm	Profil Kodu	(kg/mt)
BOTTOM SASH PROFILE (10 MM)	Profile Code	Weight
	12018	1,165

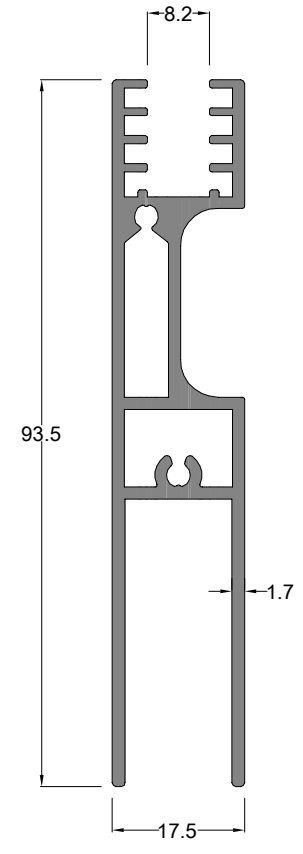

Alt Kanat 8 mm	Profil Kodu	(kg/mt)
BOTTOM SASH PROFILE (8 MM)	Profile Code	Weight
	12017	1,189

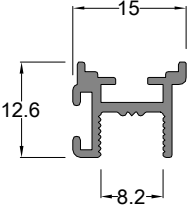

Üst Kanat Profili 8 mm	Profil Kodu	(kg/mt)
TOP SASH PROFILE (8 MM)	Profile Code	Weight
	5429	0,156

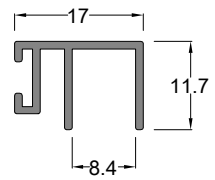

Yan Kanat Profili 8 mm	Profil Kodu	(kg/mt)
SIDE SASH PROFILE (8 MM)	Profile Code	Weight
	6198	0,143

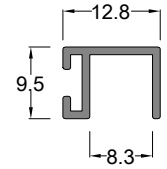

Son Kanat 8 mm	Profil Kodu	(kg/mt)
LAST SASH PROFILE (8 MM)	Profile Code	Weight
	7187	0,098

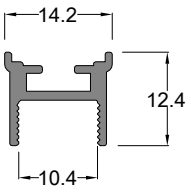

Üst Kanat 10 mm	Profil Kodu	(kg/mt)
TOP SASH PROFILE (10 MM)	Profile Code	Weight
	6196	0,143

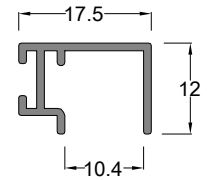

Yan Kanat 10 mm	Profil Kodu	(kg/mt)
SIDE SASH PROFILE (10 MM)	Profile Code	Weight
	6199	0,134

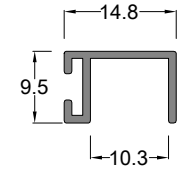

Son Kanat 10 mm	Profil Kodu	(kg/mt)
LAST SASH PROFILE (10 MM)	Profile Code	Weight
	7191	0,103

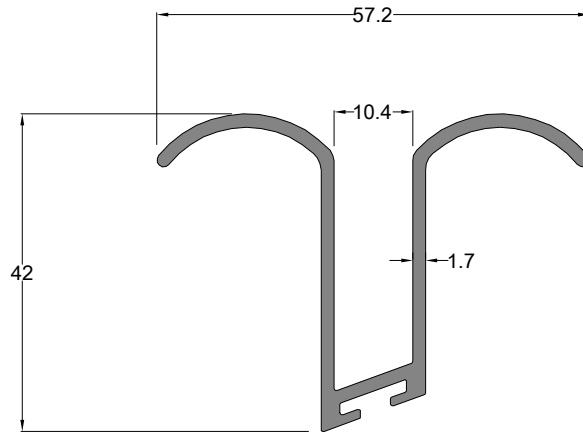

Kulp Profili 10 mm	Profil Kodu Profile Code	(kg/mt) Weight
HANDLE PROFILE (10 MM)	9676	0,640

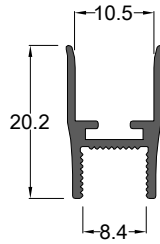

Cam H Profili (8 mm)	Profil Kodu Profile Code	(kg/mt) Weight
GLASS H PROFILE (8 MM)	7326	0,169

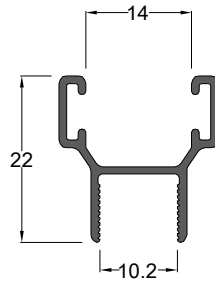

Cam H Profili (10 mm)	Profil Kodu Profile Code	(kg/mt) Weight
GLASS H PROFILE (10 MM)	8766	0,196

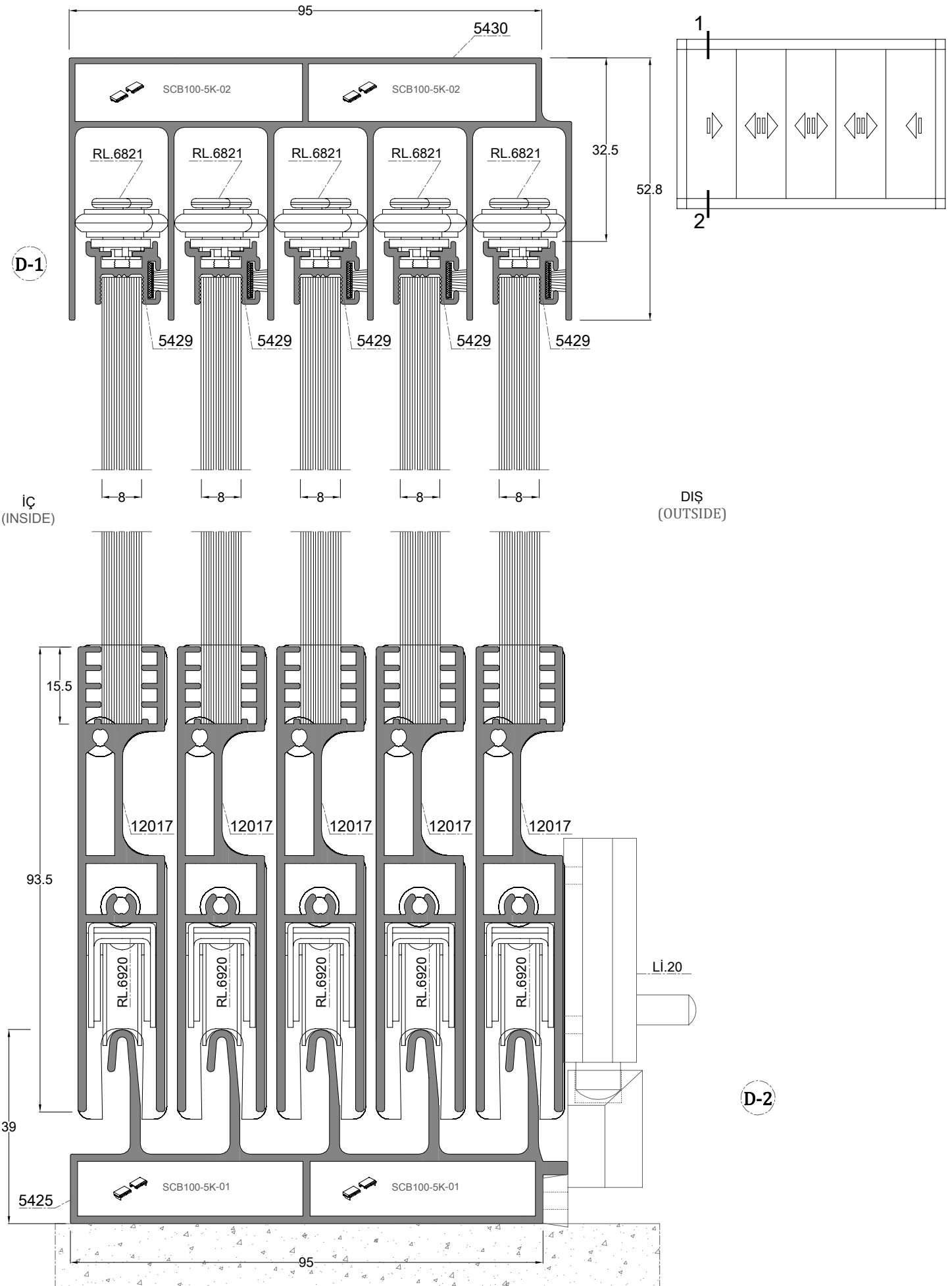

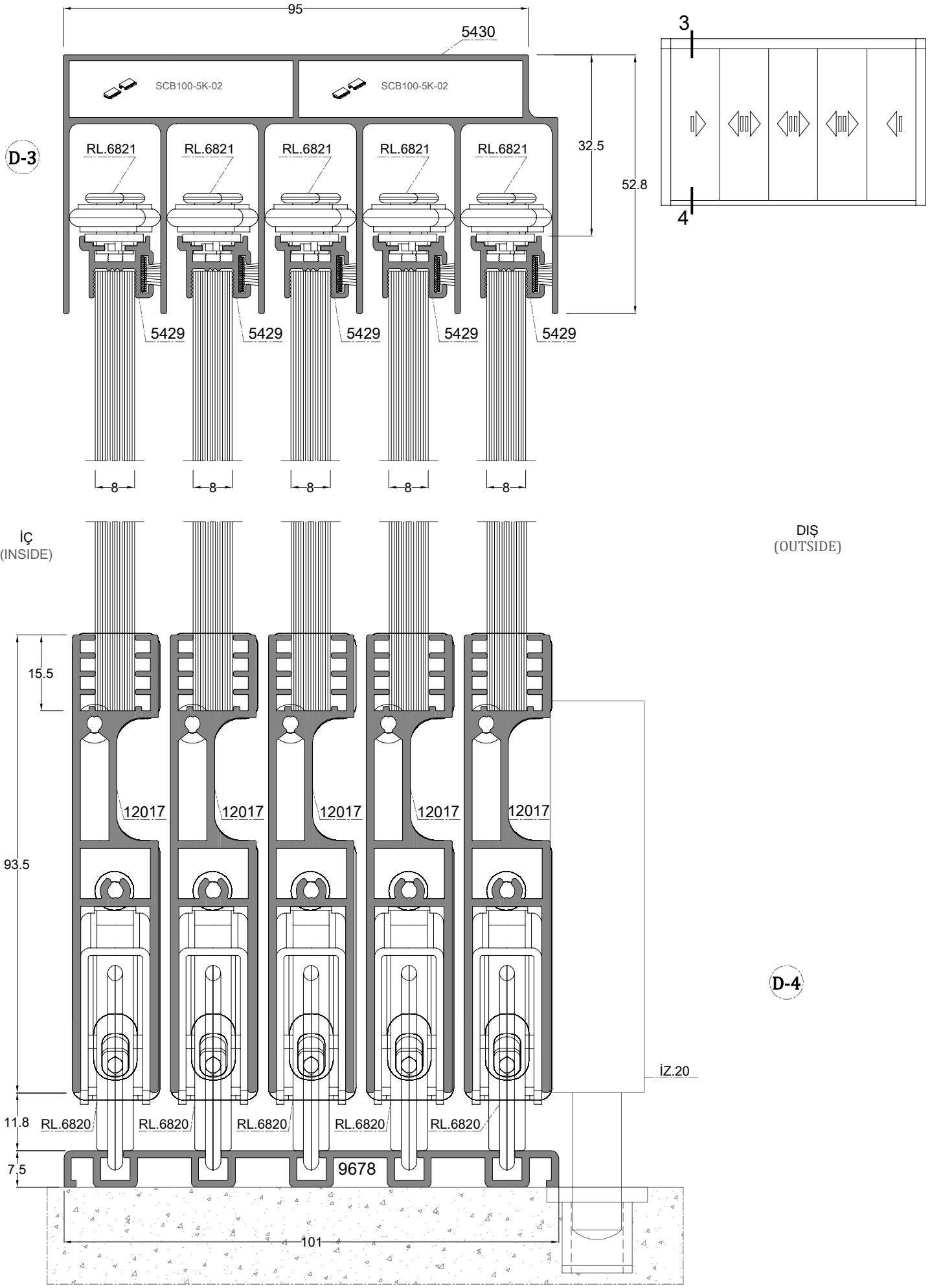

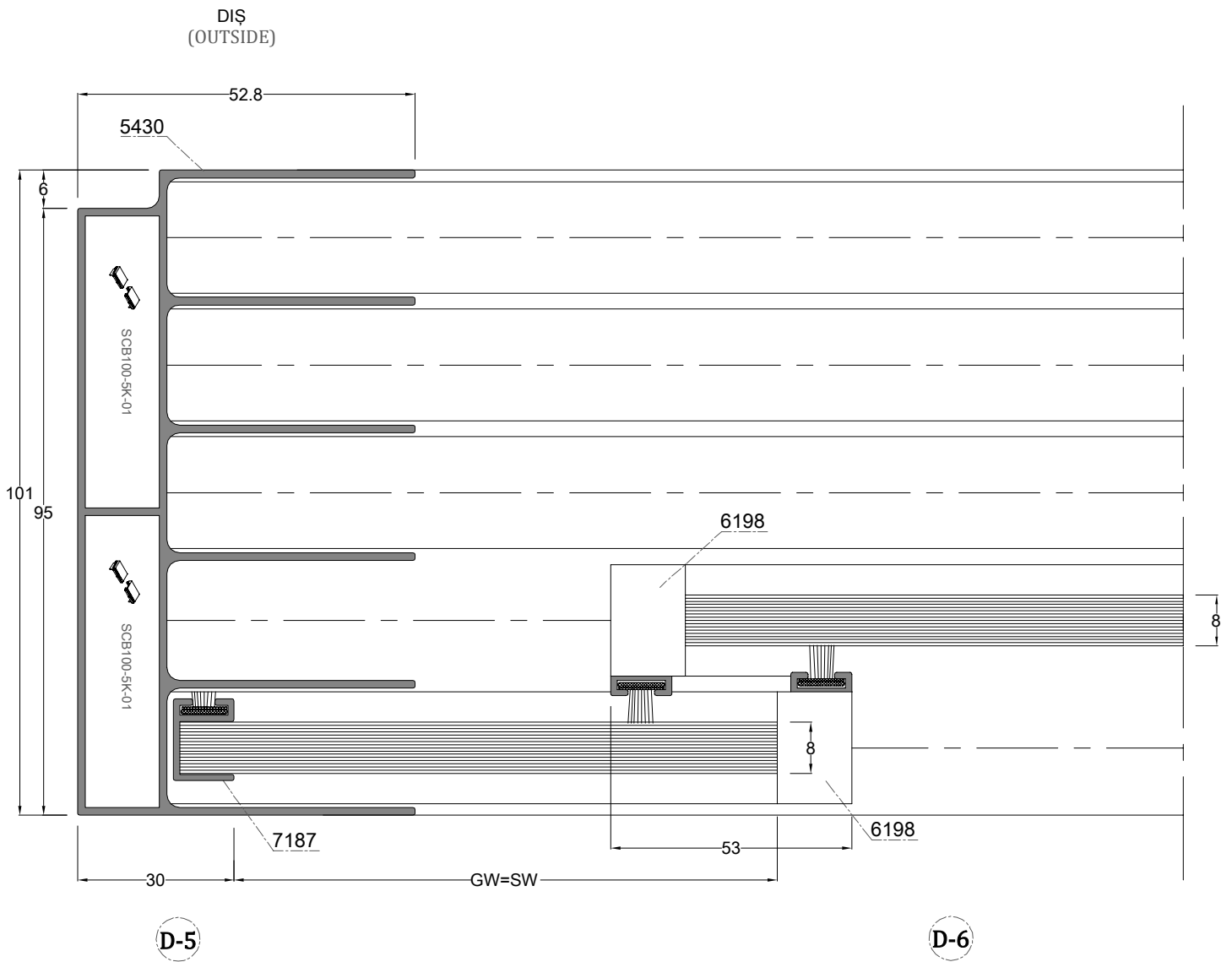
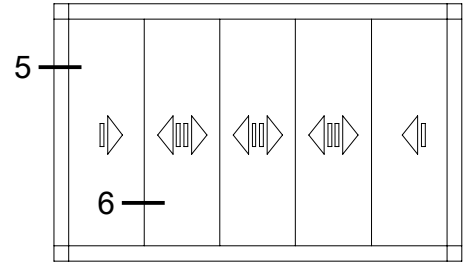
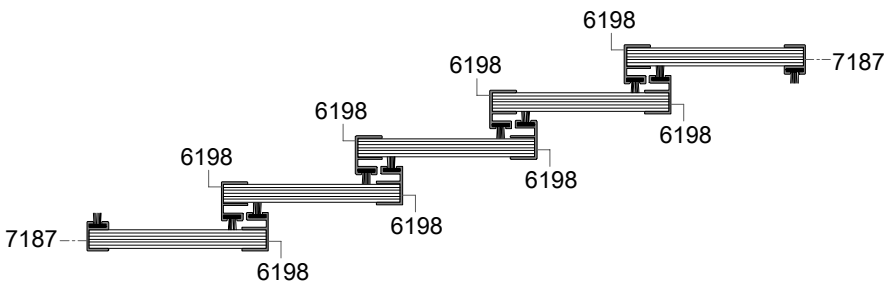

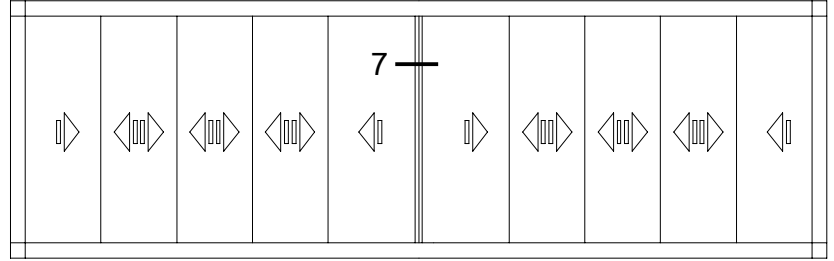

DIŞ
(OUTSIDE)

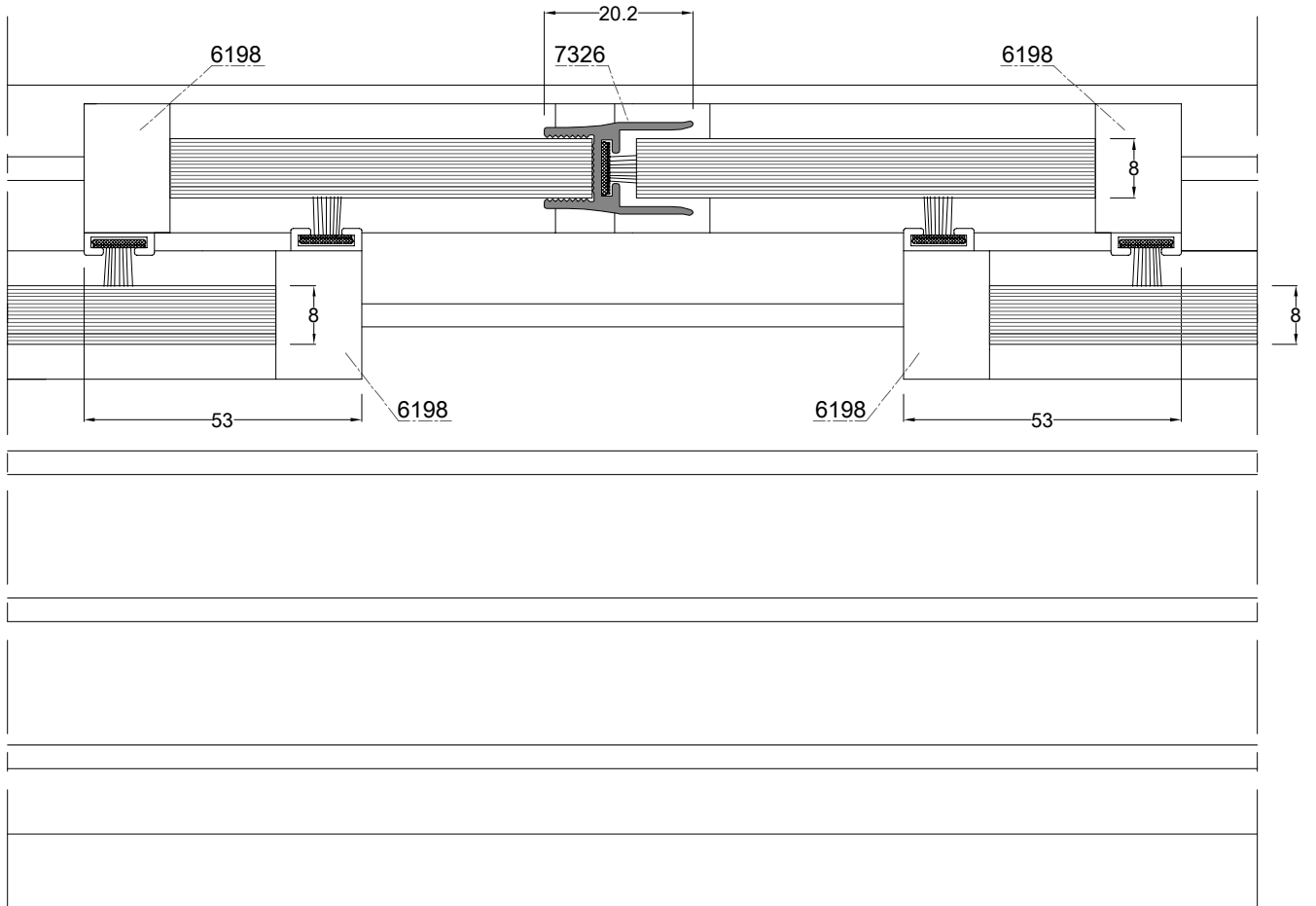

İÇ
(INSIDE)

D-7

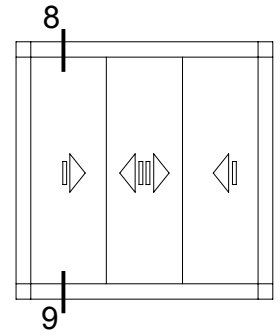
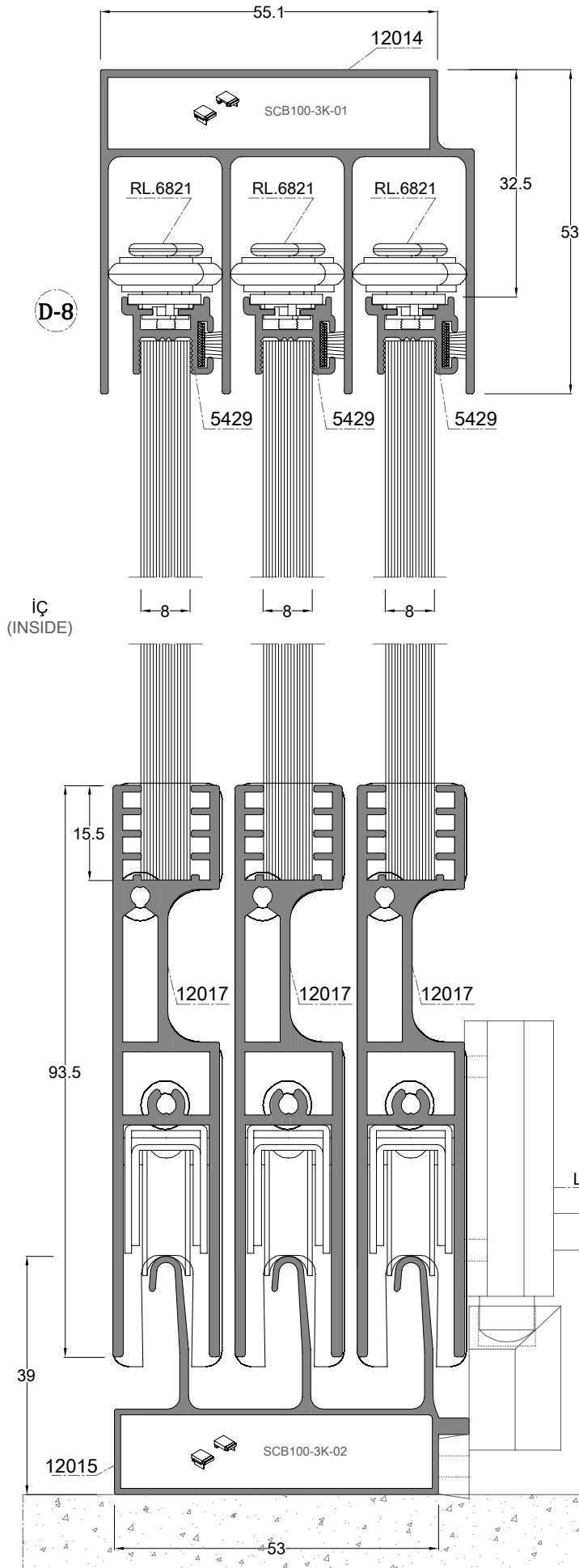

DIŞ
(OUTSIDE)

D-9

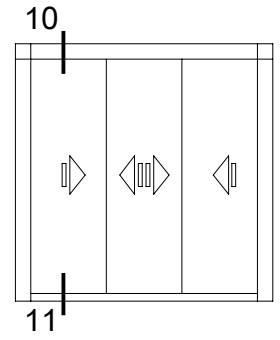
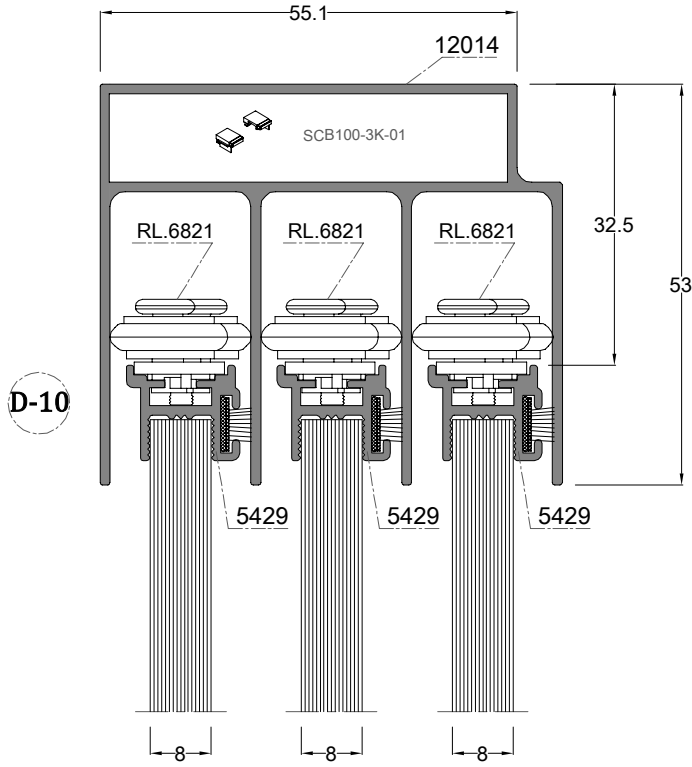

İÇ
(INSIDE)

DIŞ
(OUTSIDE)

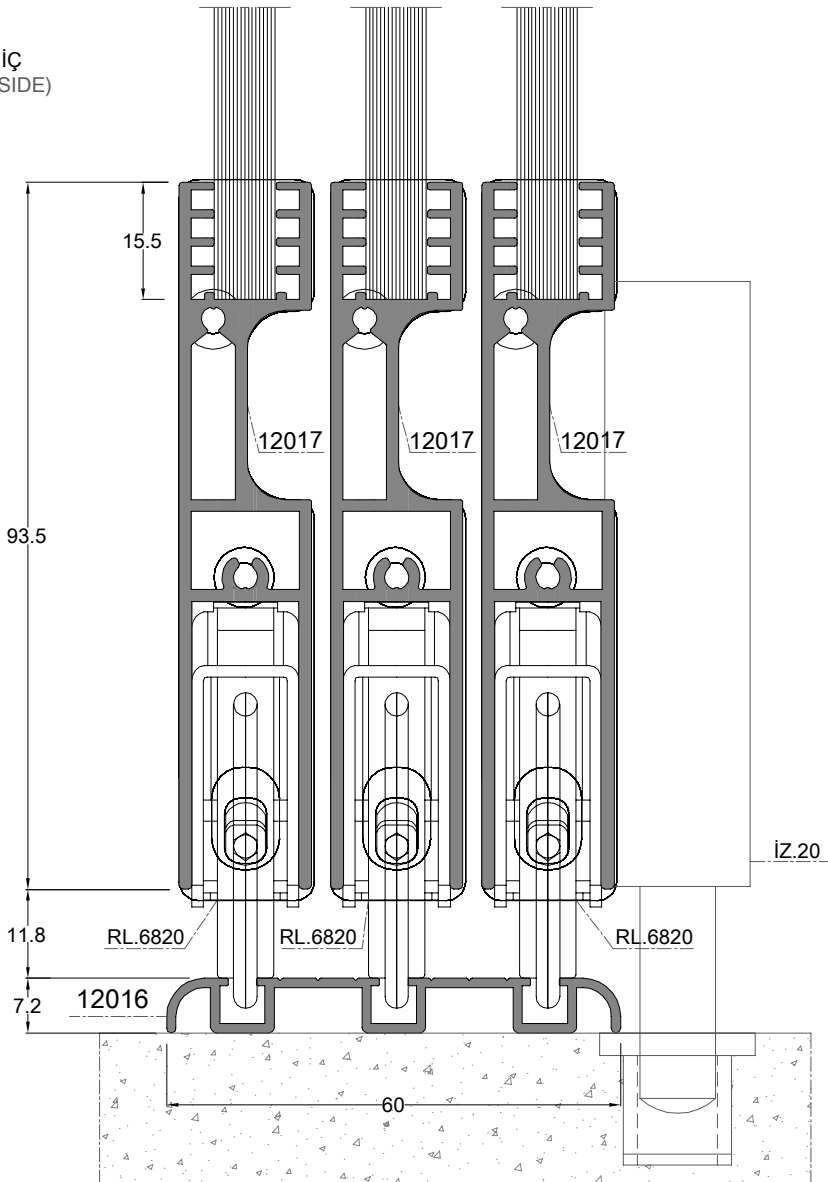

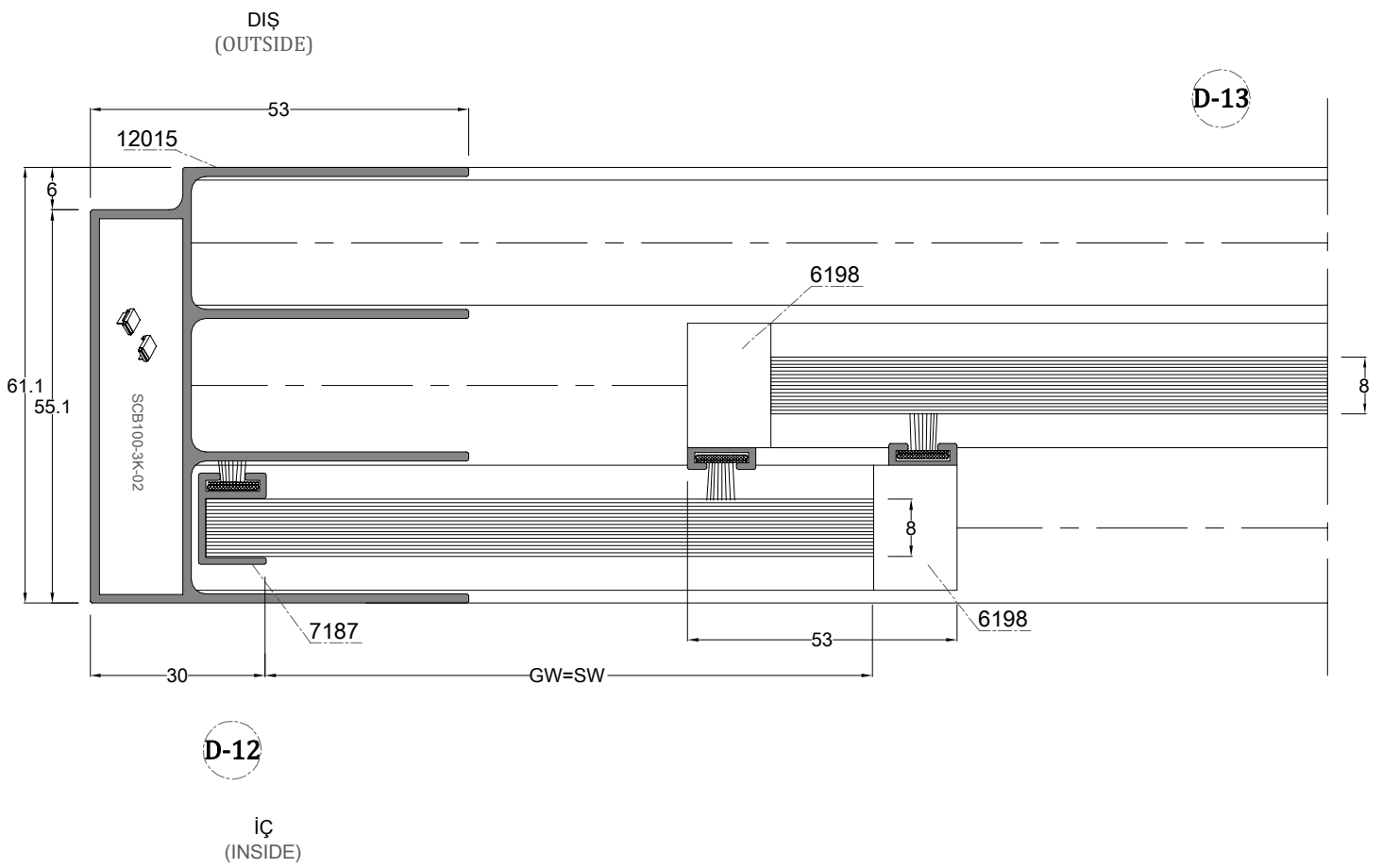
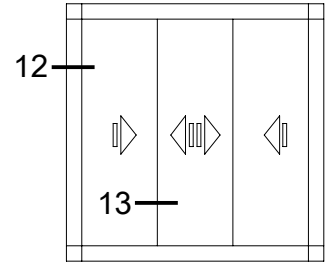

Eşikli Sistem Cam Ölçüsü
GLASS DIMENSION FOR THRESHOLD SYSTEM

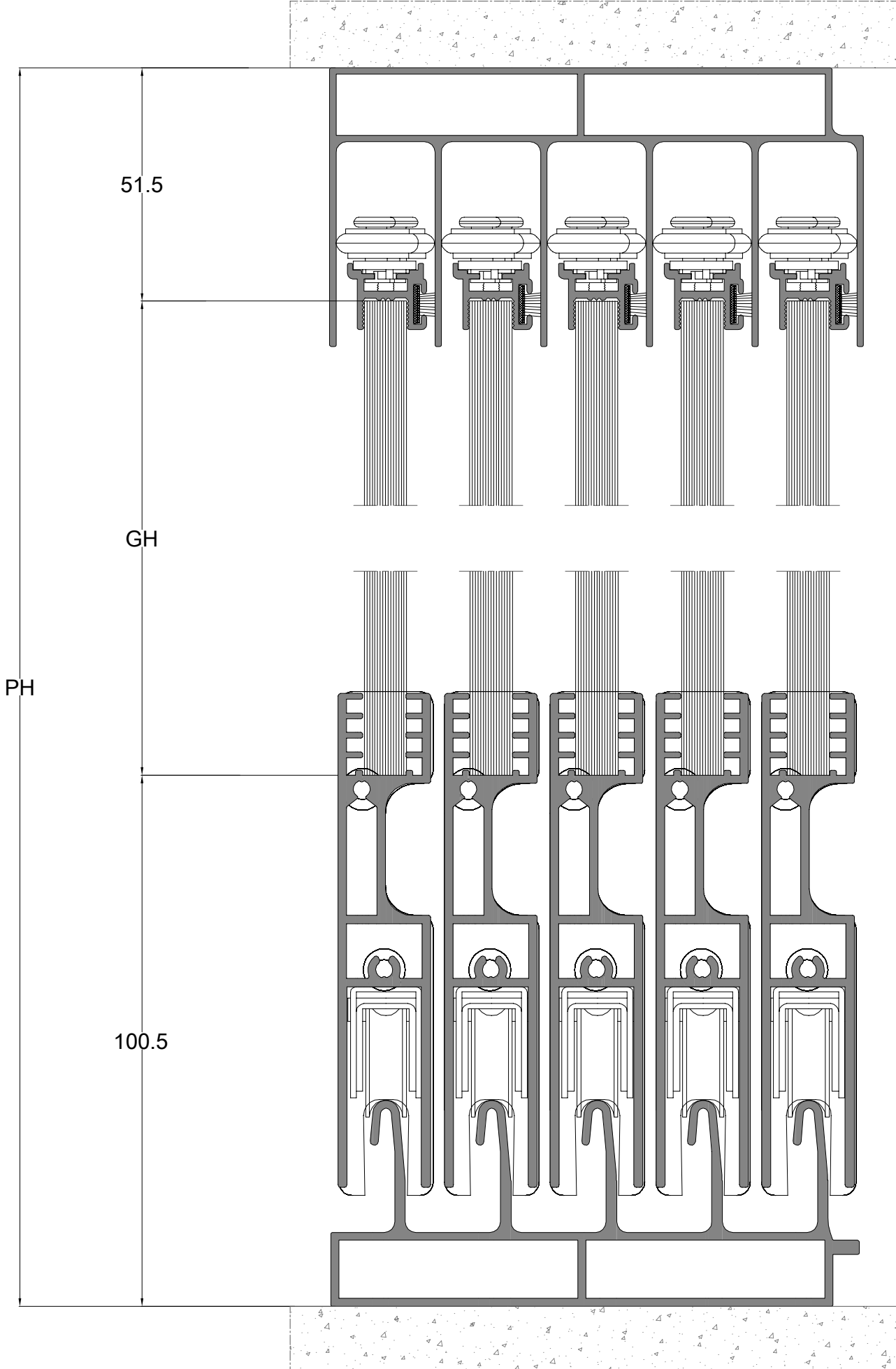

Eşikli Sistem Cam Ölçüsü
GLASS DIMENSION FOR THRESHOLD SYSTEM

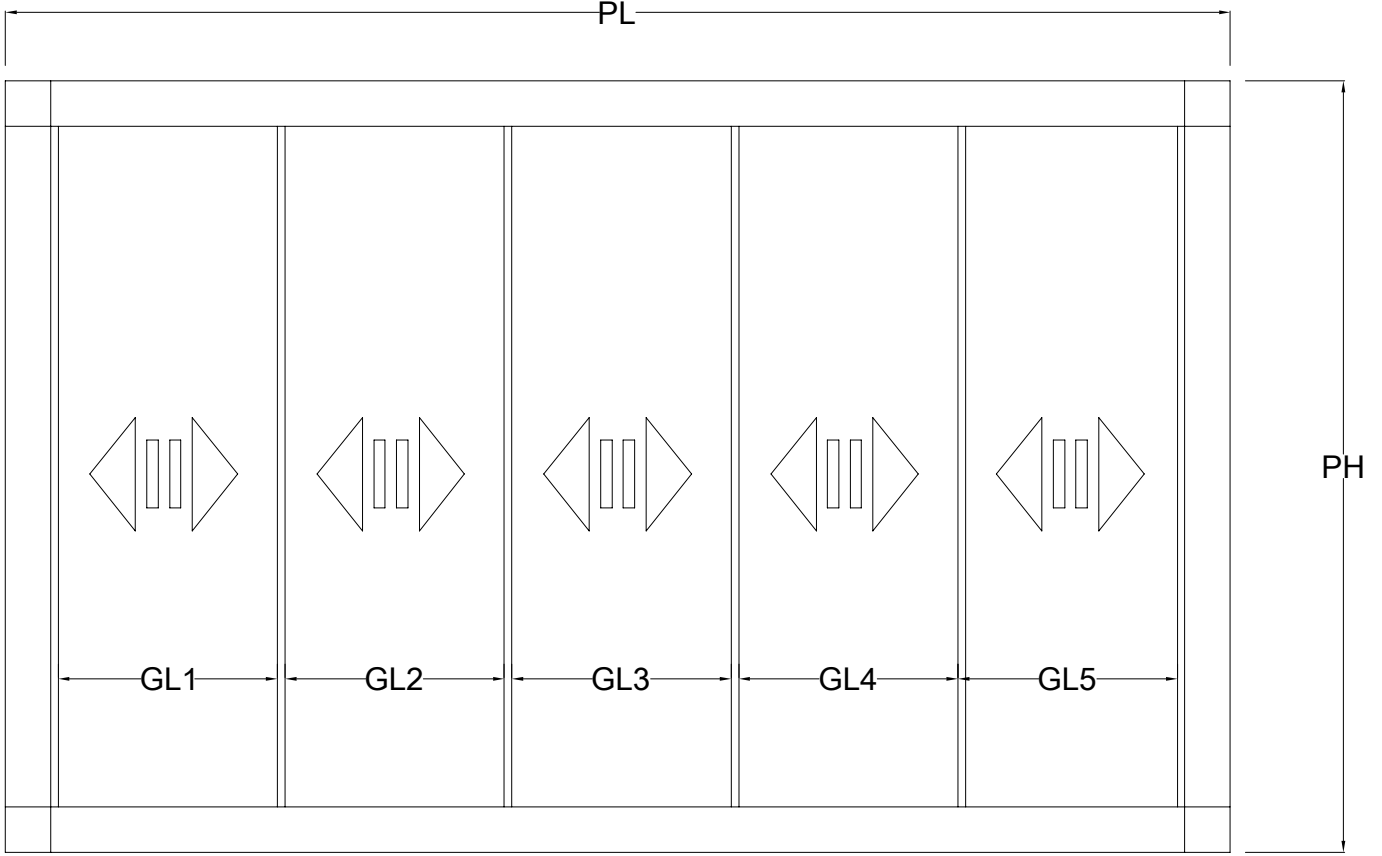

$$GL \text{ (CAM GENİŞLİĞİ)} = \left(\frac{PL \text{ (PANEL GENİŞLİĞİ)}}{A \text{ (KANAT ADETİ)}} \right) + 8 \text{ mm}$$

$$GL = GL1 = GL2 = GL3 = GL4 = GL5$$

$$GH \text{ (CAM YÜKSEKLİĞİ)} = PH \text{ (PANEL YÜKSEKLİĞİ)} - 152 \text{ mm}$$

Eşikli Sistem Profil Kesim Ölçüsü
PROFILE CUT DIMENSION FOR THRESHOLD SYSTEM

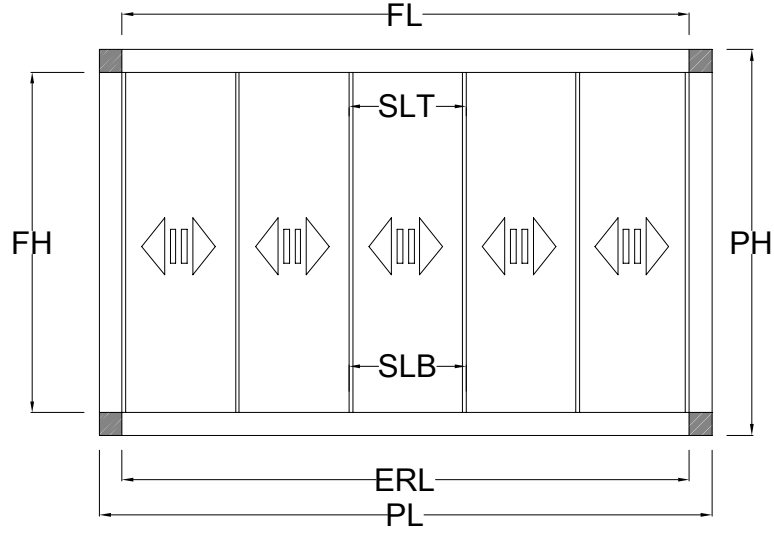

ERL (EŞİKLİ ALT RAY GENİŞLİĞİ) = PL (PANEL GENİŞLİĞİ) - 104 mm

FL (ÜST KASA GENİŞLİĞİ) = PL (PANEL GENİŞLİĞİ) - 104 mm

FH (YAN KASA YÜKSEKLİĞİ) = PH (PANEL YÜKSEKLİĞİ) - 30 mm

SLB (ALT KANAT GENİŞLİĞİ) = $\left(\frac{PL (PANEL GENİŞLİĞİ)}{A (KANAT ADETİ)} \right) + 8 \text{ mm}$

SLT (ÜST KANAT GENİŞLİĞİ) = $\left(\frac{PL (PANEL GENİŞLİĞİ)}{A (KANAT ADETİ)} \right) + 8 \text{ mm}$

SH (KANAT ÇITA YÜKSEKLİĞİ) = PH (PANEL YÜKSEKLİĞİ) - 168 mm

Eşiksiz Sistem Cam Ölçüsü
GLASS DIMENSION FOR NON-THRESHOLD SYSTEM

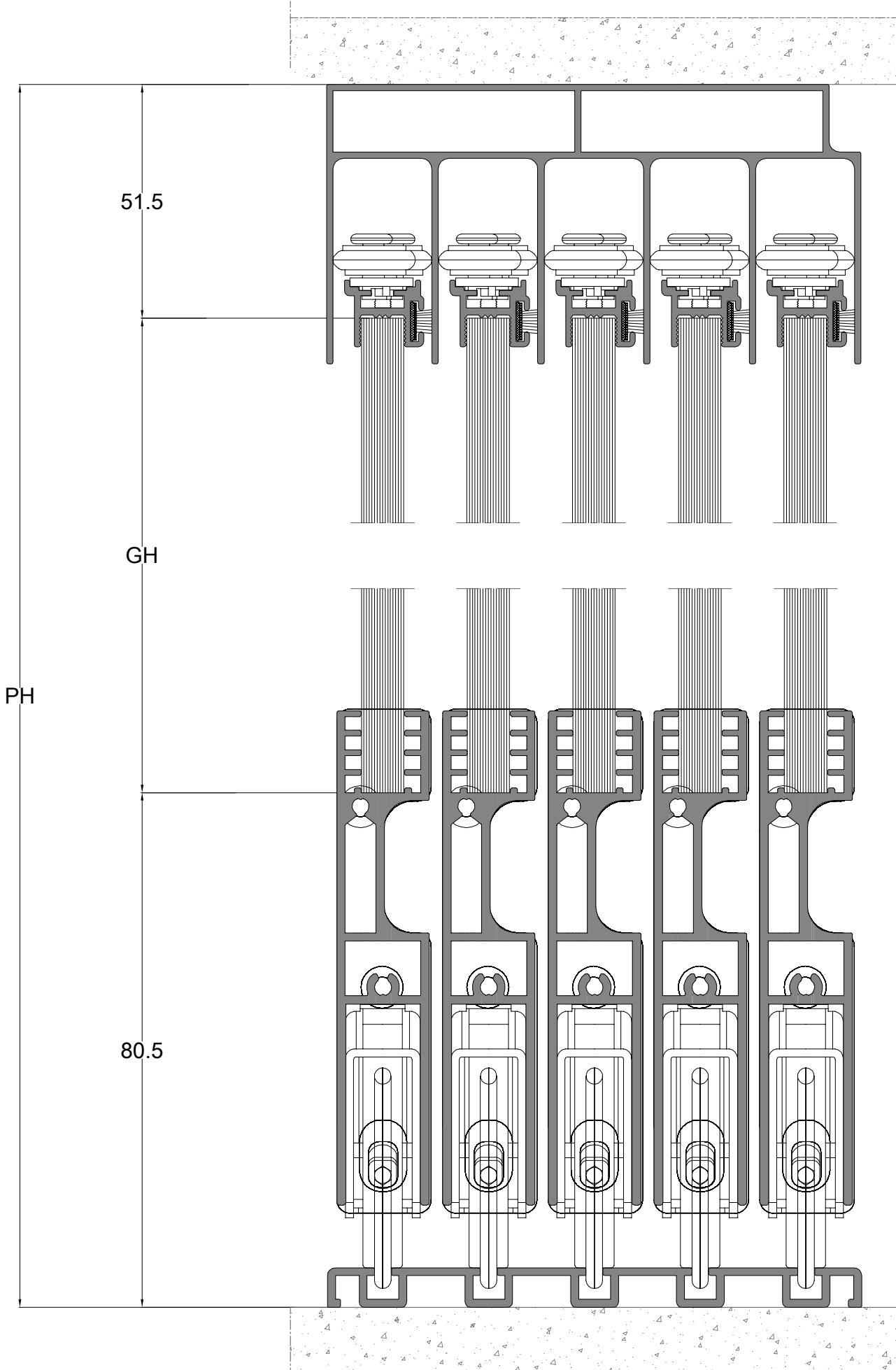

Eşiksiz Sistem Cam Ölçüsü
GLASS DIMENSION FOR NON-THRESHOLD SYSTEM

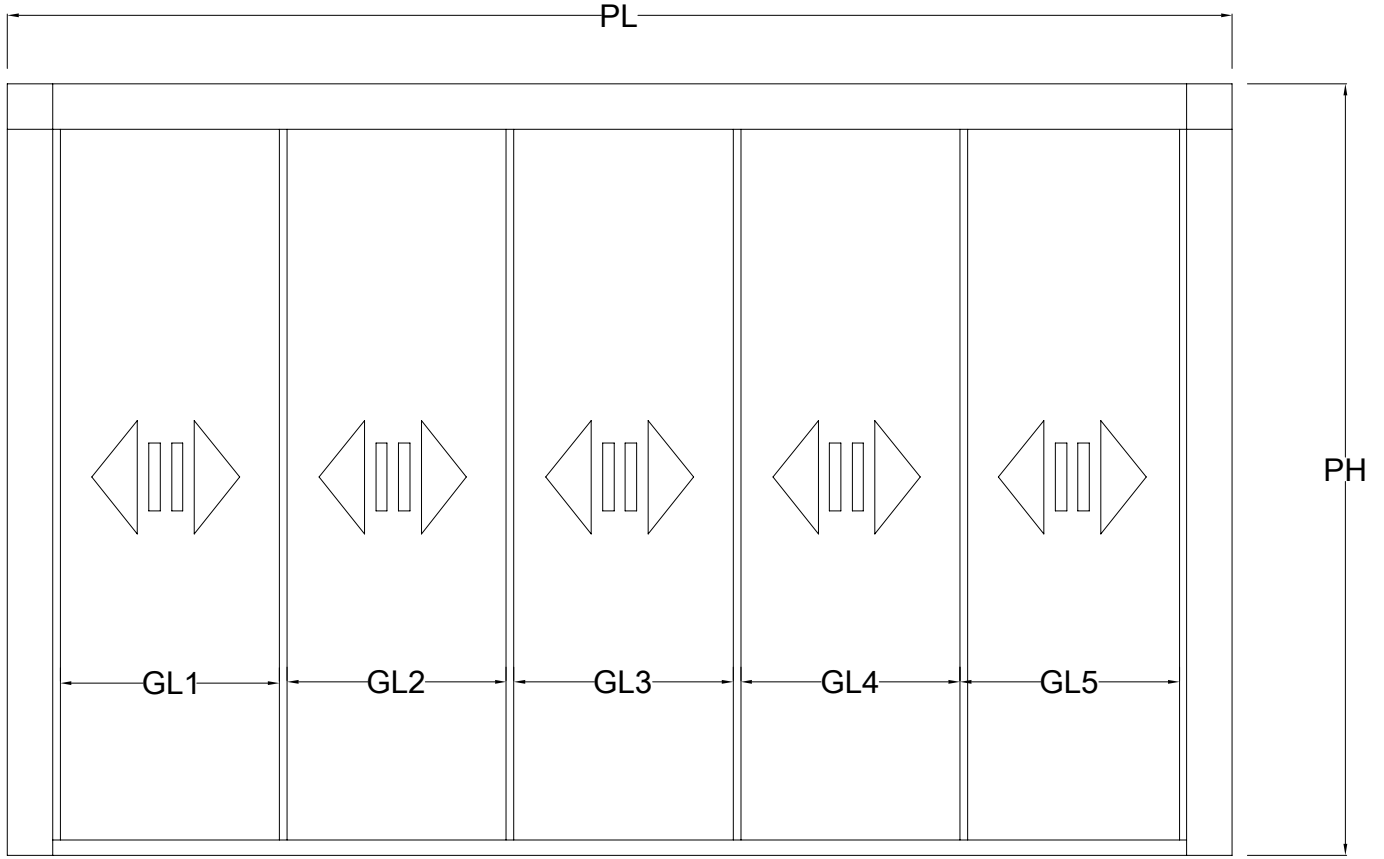

$$GL \text{ (CAM GENİŞLİĞİ)} = \left(\frac{PL \text{ (PANEL GENİŞLİĞİ)}}{A \text{ (KANAT ADETİ)}} \right) + 8 \text{ mm}$$

$$GL = GL1 = GL2 = GL3 = GL4 = GL5$$

$$GH \text{ (CAM YÜKSEKLİĞİ)} = PH \text{ (PANEL YÜKSEKLİĞİ)} - 132 \text{ mm}$$

Eşiksiz Sistem Profil Kesim Ölçüsü
PROFILE CUT DIMENSION FOR NON-THRESHOLD SYSTEM

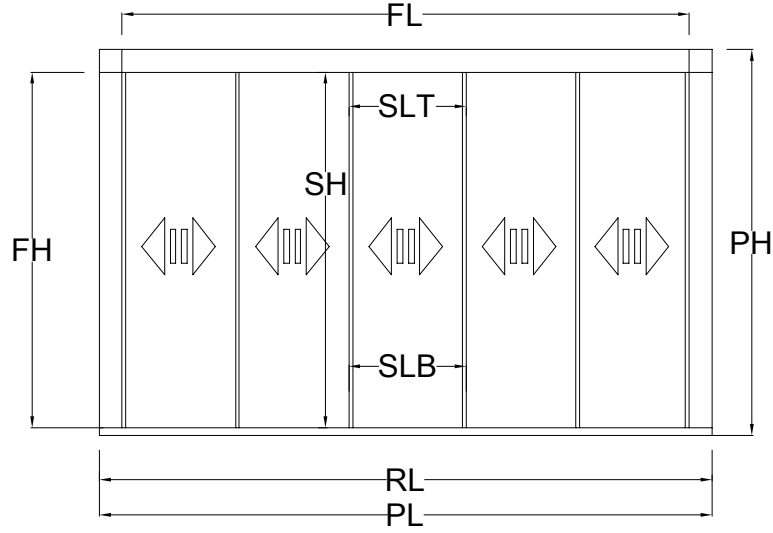

RL (EŞİKSİZ ALT RAY GENİŞLİĞİ) = PL (PANEL GENİŞLİĞİ)

FL (ÜST KASA GENİŞLİĞİ) = PL (PANEL GENİŞLİĞİ) - 104 mm

FH (YAN KASA YÜKSEKLİĞİ) = PH (PANEL YÜKSEKLİĞİ) - 22 mm

SLB (ALT KANAT GENİŞLİĞİ) = $\left(\frac{PL \text{ (PANEL GENİŞLİĞİ)}}{A \text{ (KANAT ADETİ)}} \right) + 8 \text{ mm}$

SLT (ÜST KANAT GENİŞLİĞİ) = $\left(\frac{PL \text{ (PANEL GENİŞLİĞİ)}}{A \text{ (KANAT ADETİ)}} \right) + 8 \text{ mm}$

SH (KANAT ÇITA YÜKSEKLİĞİ) = PH (PANEL YÜKSEKLİĞİ) - 148 mm